



Spectra VX³



Owner's Manual

White's Electronics, Inc.

Sweet Home, Oregon USA

*Building the World's Finest
metal detectors for over 60 years.*



Congratulations! You have purchased a quality instrument that was designed and manufactured in the USA.

The Spectra series is the result of years of research and development, time-proven manufacturing and testing techniques, and, most of all... listening to our customers.

The *Spectra VX³* represents the state-of-the-art in metal detecting technology. Three frequencies, color display, advanced features, and the ability to use wireless headphones produce a powerful and capable detector. *VX³* has preset programs developed and refined by experts, leaving you ready to find what others have left behind.

This instruction manual covers the features of *VX³* and introduces the detecting basics you need to get started. There are no substitutes for field experience; study this manual, and practice using your *Spectra VX³*. Before long, you may well be teaching the experts a thing or two.

I am proud of the *Spectra VX³*, and the people here at White's who designed and built it for you. We've been designing, building, and distributing world-wide for over 60 years from our factory in Sweet Home, Oregon, USA. We put our "Made in America" label on every metal detector we build!

Happy Hunting!

President
White's Electronics, Inc.



VX³ Specifications

Operating mode	VLF/induction balance
Frequencies	2.5kHz, 7.5kHz, 22.5kHz
Ground balance range	Ferrite to salt (approx. 95°)
Programs	8, all modifiable
Discrimination segments	191
Audio modes	4: Std, all-metal, mixed mode, pinpoint
Audio tones	1 or 191
Audio output	Speaker, headphones, wireless headphones
Display	320x240 QVGA Color, backlit
Weight	4.3 lbs
Length	45 - 52.5 inches, adjustable
Search coil	Eclipse 950 9.5" concentric
Batteries	(8) AA, alkaline
Battery life	8-10 hours typical ¹
Warranty	2 years, transferrable

Customer Support

Questions concerning your *VX³*? There are three ways to contact us:

Internet: <http://whiteselectronics.com/support.html>

Phone:

1-800-547-6911 (US)

(0044) 1463 223456 (UK)

Or mail us:

White's Electronics
1011 Pleasant Valley Road
Sweet Home, OR 97386

White's Electronics
35 Harbour Road
Inverness, Scotland
IV1 1UA

1. Alkaline batteries, backlight off, no wireless headphones

Table of Contents

1 Introduction

Conventions	1-2
Layout	1-3
Assembly	1-5
Batteries	1-6
The Basics of VLF Operation	1-7

2 QuickStart

Turn On & Go	2-1
Programs and Memory	2-2
Ground Balance	2-3
Electromagnetic Interference (EMI)	2-4
Menus & Controls	2-4
Live Control Bar	2-5
Main Menu	2-5
Controls	2-6
<i>VX³</i> Displays	2-6
Search mode	2-6
Pinpoint mode	2-7
<i>VX³</i> Audio	2-8
Metal Detecting Basics	2-8

3 Basic Settings

Programs	3-2
Backlight	3-3
Sensitivity	3-4
Rx Gain	3-4
All-Metal Sensitivity	3-5
Discrimination Sensitivity	3-6
Audio	3-6
Discrimination	3-6
Frequency	3-7
Ground Tracking	3-8
Filters	3-9

4 Operating Modes

Frequency	4-1
Three Frequency	4-2
Salt Compensate	4-2
Single Frequency	4-3
Frequency Offset	4-4
Ground Balance	4-5
AutoTrac	4-5
LockTrac	4-6
Audio	4-6
All-Metal Audio	4-7
Discrimination Audio	4-10
Mixed-Mode Audio	4-12
Pinpoint Mode	4-13
Discrimination	4-14
Speaker and Headphones	4-15
Preset Icon Tables	4-16

5 Display Screens

Search screen	5-1
VDI	5-2
Icons	5-3
Depth	5-3
SpectraGraph	5-3
Status Bar	5-8
Pinpoint Screen	5-9
Salt Mode Anomaly	5-9

6 Advanced Features

Main Menu	6-1
Filters & Speed	6-2
Ground Filter	6-3
Recovery Delay	6-4
SAT	6-5
Sensitivity Probe	6-5
Ground Probe	6-6

7 Programs

<i>VX³</i> Memory Structure.....	7-1
Saving Programs	7-2
Restoring Programs	7-2
Rearranging Programs	7-3

8 Wireless Headphones

9 Troubleshooting

10 Shortcuts

Back Cover: Warranty; Code of Ethics

White's *VX³* represents the latest technology in metal detecting. The heart of *VX³* is a high-performance ARM-9 RISC microprocessor which simultaneously analyzes signals from 3 transmitted frequencies. Those frequencies — 2.5kHz, 7.5kHz, and 22.5kHz — were chosen for their diverse responses to a variety of metal targets, resulting in a superior system of target analysis and identification.

The face of *VX³* is a stunning 320x240 color display with an easy-to-use menu-driven interface. Along with three frequencies, there are three search modes and a three-level Spectra-Graph® display which provides detailed target information for each frequency. With a level of simplicity for the novice user and advanced features to satisfy the experienced user, *VX³* is a metal detector for everyone.

This manual is organized to provide progressive information, a format that attempts to minimize information overload. If you are a new detectorist, the *QuickStart* chapter will allow you to get a quick jump on using *VX³*. Then, as you run across new features and want to find out more, continue reading the manual to get progressively detailed information.

If you are already familiar with high-end detectors (especially those with a menu interface), you might want to read over the *QuickStart* chapter to get a feel for *VX³*'s features. *VX³*'s graphical interface makes the rest easy.

While *VX³* is easy to use, it does have more features than many other detectors, and can appear overwhelming. Don't be intimidated! Start with the preset programs and go at your own

pace. There is no need to master all the features to get excellent performance.

If you need help, White's Electronics is a phone call or mouse click away. Your dealer is an excellent resource, and the White's web site has a VX³ help forum for questions & answers, tips, and sharing programs. Go to www.whiteselectronics.com and click on the Forum link. There are also many other on-line forums for metal detecting where you can chat with other White's users and ask questions. Finally, look for a detecting club in your area. Members are often eager to help people get started, and there is nothing like having that help close by in the field.

Conventions

In discussing the features of VX³, we will use **Arial-Bold-Caps** to distinguish keypad buttons and menu selections. For example, “press **ENTER**” means to press the “Enter” key on the keypad, and “select **Enable**” might mean to select the “Enable” menu option, probably by using the arrow keys to highlight it and then pressing **ENTER**. VX³ keys and menus work just like a modern computer graphical interface, so things are fairly intuitive.

In some cases, you need to use multiple key combinations, or combinations with the trigger switch. “Press **MENU, ENTER**” means to press and release the **MENU** button, then press and release the **ENTER** button. But “press **MENU+ENTER**” means to press and hold the **MENU** button, and while holding it down press the **ENTER** button. Order often matters, so **MENU+ENTER** is not the same as **ENTER+MENU**. If you find that you have accidentally pressed the wrong key or key combo, pulling the trigger switch will usually back you out.

Tip: Keypad buttons usually take you into menus, trigger gets you out.

Two keypad buttons have dual names. **MENU/TAB** is used both as an entry button into the menu system, and to “tab” from one screen area to the next. This tab method is identical to how a PC interface uses it. So in some cases we will tell you to press **MENU**, in other cases press **TAB**. It's the same button. **ZOOM/VIEW** works the same way. *VX³* also has four arrow keys, and these may be either called **UP DOWN LEFT RIGHT** (or **UP DN LT RT**) or represented with the symbols **▲▼◀▶**. Any of these representations might be used.

Most menus are nested, so instead of telling you to press **MENU**, then select the **Audio** menu, then select **Search Audio**, then select **Discrimination**, then select **Modulation**, we may instead say, select **MENU→Audio→Search Audio→Discrimination→Modulation**. This means to drill down through the stated menu path.

Finally, there is a trigger switch under the pod. It has a normal (center) position, a forward position, and a momentary pulled position. When we say “pull the trigger,” we mean to pull it to the momentary position and release it. If we say “Pull/hold the trigger,” then pull it back and hold it there. This might be in conjunction with a key press, such as, “Pull/hold the trigger and press **ENTER**,” which is the same as “Trigger+**ENTER**.”

Layout

The *VX³* interface consists of a keypad and a color screen. The next page has a picture of the pod face with the default layout for the search screen. The search screen has four major regions:

1. Target information
2. SpectraGraph
3. Status Bar
4. Live Control Bar

The target information includes the “VDI” number, the depth, and icons representing the likely target. SpectraGraph displays

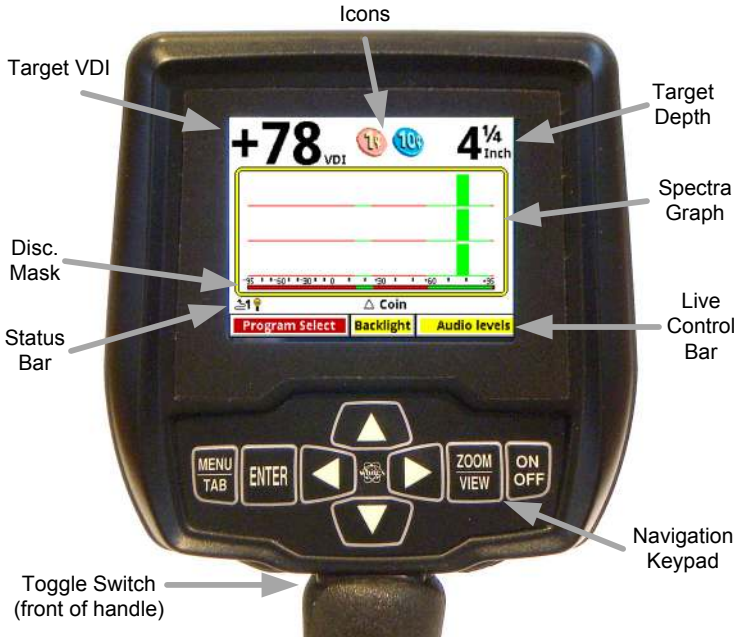

signal strength versus VDI and gives a detailed look at the VDI response. The status bar shows a few operational pieces of information, and the Live Control Bar provides quick on-the-fly access to operating modes and adjustment parameters. All of these will be covered in detail in subsequent chapters.

Assembly

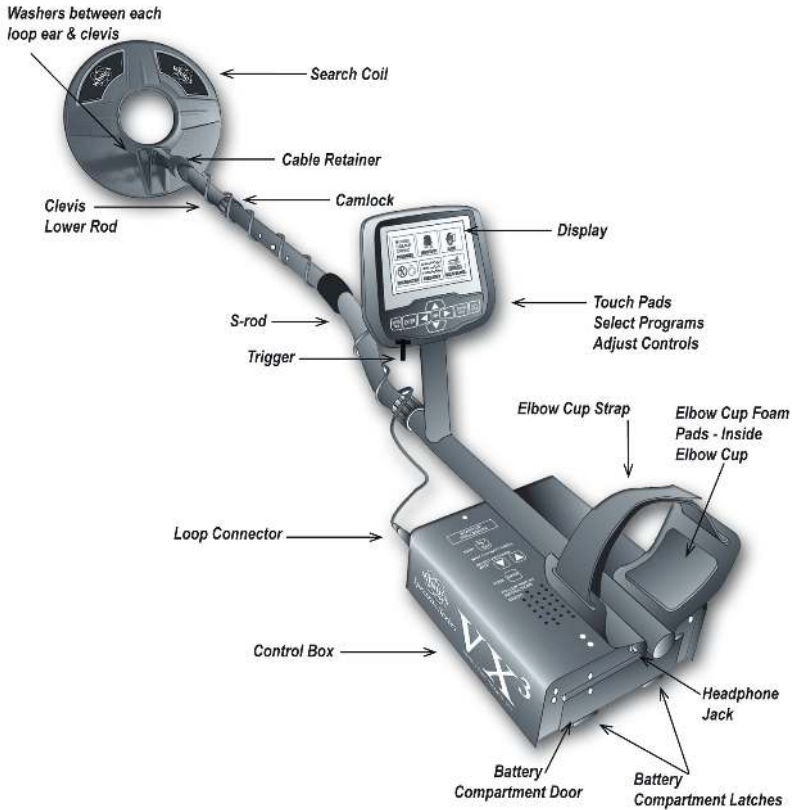

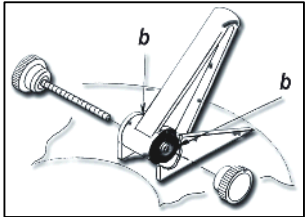
1. Remove all parts from the shipping carton. Check the assembly page to ensure all parts are present.
2. Insert the 2 rubber washers (b) into the recesses of the lower rod clevis and use the fiber bolt and thumb nut to secure the search loop to the lower rod.
 
3. Insert the lower rod into the “S” rod (unlock the cam lock if necessary); the spring clip buttons will click into the adjustment holes. Turn the cam lock

to secure. The second or third adjustment holes are suitable for average height adults. Exceptionally tall users may wish to consider purchase of the “tall-man” lower rod (500-0242-3) and/or the “tall-man” S-rod (500-0240-1).

4. Wind the search loop cable around the rod assembly, first revolution starting over the top of the rod. Work your way to the top of the S-rod. Use the Velcro retainers, one near the loop and one near the top, to hold the cable in place.
5. Insert the rod/loop assembly into the control box rod (unlock the cam lock if necessary); the spring clip buttons will click into the holes. Turn the cam lock to secure. Normally, the S-rod should curve upward.
6. Two adhesive black foam pads are included; they can be placed on the insides of the arm cup.
7. Adjust the Velcro arm strap so that you can easily slip your arm in and out. The strap provides extra leverage and control, though some prefer not to use it.
8. Install the battery pack (see next section for details).
9. Hold the detector normally and check for comfortable angle and balance. Adjust the lower rod extension and/or the arm cup position if necessary.

Batteries

VX³ is provided with an 8-cell AA battery pack. For best results, use either alkaline batteries or high-capacity rechargeable (such as NiMH) batteries. Also available from White's is a NiMH rechargeable pack plus recharging station; contact your dealer or White's directly for details.

To install the batteries:

- Release the battery door latches on *VX³* to open the battery door.
- Slide the battery pack in, with the metal contact plates facing forward.

To replace the batteries, slide open the battery holder lid by gently lifting the tab.

A fresh set of alkalines will operate VX³ for about 7-8 hours with no backlight. Use of the backlight will reduce battery life. When you first power-up VX³ a start-up screen will display briefly with the battery voltage at the bottom. During operation, if the battery voltage drops below 8 volts a low-battery icon will display in the status bar:

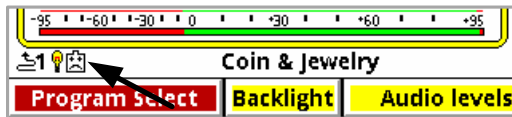

You can also check the voltage at any time by selecting **Backlight,VIEW** from the Live Control Bar, or pressing **MENU+ENTER** to bring up the Info screen.

VX³ automatically powers off if no activity occurs in a 20 minute time span. Activity is defined as the use of the keypad or the trigger switch.

The Basics of VLF Operation

VX³ is a multi-frequency (MF) induction-balance (IB) very low frequency (VLF) transmit-receive (TR) metal detector. In order to understand what all the user adjustments do, it is important to have at least a rudimentary understanding of how a modern metal detector works.

Metal detectors work on the principle of induction, discovered by Michael Faraday in 1831. The typical induction-balance metal detector¹ uses a transmit coil to produce a magnetic field, and this magnetic field in turn produces a small reaction in nearby metal targets. A receive coil is used to detect this small

1. The first practical metal detector was an induction-balance design, built by Alexander Graham Bell in an effort to locate an assassin's bullet lodged in US President James Garfield. He failed — not enough sensitivity. Ever since then, “more sensitivity” has been the goal of every detector.

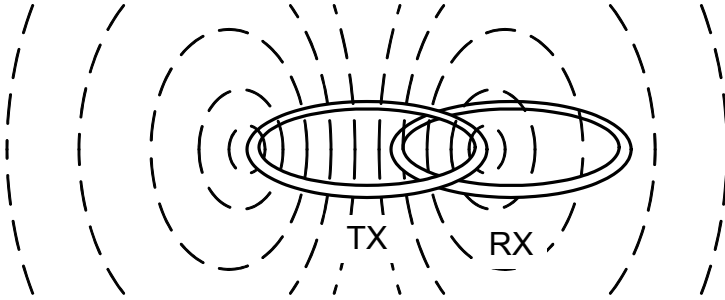

reaction. A so-called “induction-balanced” coil arrangement prevents the receive coil from being overwhelmed by the transmit signal, allowing it to see very small target signals.

Phase & VDI

Practically all VLF-IB detectors operate as phase discriminators. The received signal is converted to phase, and the phase is a strong indication of what the target might be. The particular phase of a target can vary with the frequency of the transmitted signal, so different detectors designed to use different frequencies can report completely different phase results.

To keep users from having to learn all these different phase response scales, White’s has chosen to normalize them all to a standard “VDI” scale. VDI stands for *Visual Discrimination Indicator* and is simply a consistent numerical value assigned to targets regardless of the frequency being used. Therefore, a US nickel detected with a 6kHz detector will have the same VDI as with a 15kHz detector. For historical reasons, the standard VDI scale is based on a 6.592kHz detector and is shown below.

The ability to separate targets by VDI is what allows a detector to discriminate. Targets with a negative VDI are usually ferrous (iron), and targets with a positive VDI are usually non-ferrous. Small gold tends to have low VDI’s while thick silver coins have high VDI’s. Other targets like cupro-nickel coins, brass and bronze relics, and aluminum trash can have wildly varying VDI’s depending on their alloy, size, and thick-

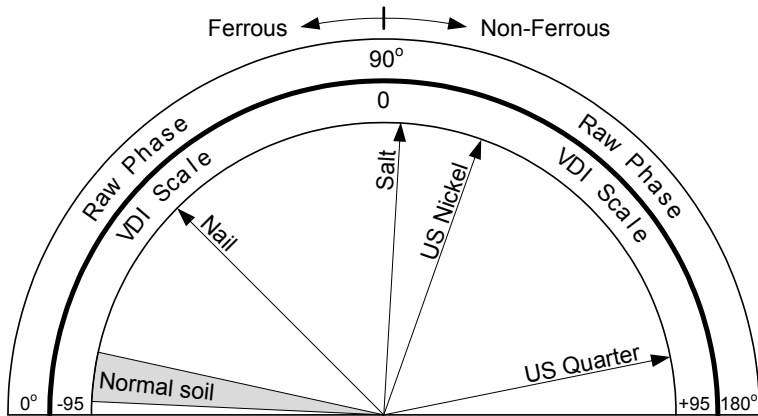

ness. This means you need to apply your own discriminator — your brain — in deciding what the VDI responses are telling you.

Ground Response

Unfortunately, buried metal is not the only thing the detector sees. Most soil contains ferric oxide minerals, and this mineralization looks like a target². In terms of VDI, practically all ground mineralization falls in the extreme negative range of the scale, even beyond most iron targets. But it can vary somewhat as shown by the gray range in the prior diagram. At most locations the variation is small, so you can ground balance at a particular spot and be very close for the entire area. Some locations have significant variations and you should occasionally re-ground balance as you hunt, or use automatic ground tracking.

Many locations have enough mineralization to create quite a strong ground signal, often much stronger than that of a moderately deep target. The VDI diagram on the preceding page uses vectors to represent specific target responses, with the angle of the vector representing the VDI value. We can also use the length of the vector to represent the strength of the target

2. In this manual, we'll refer to the signal resulting from ground mineralization (including salts) as the "ground signal" or the "ground response."

response, so that a strong ground and weak quarter response would look like:

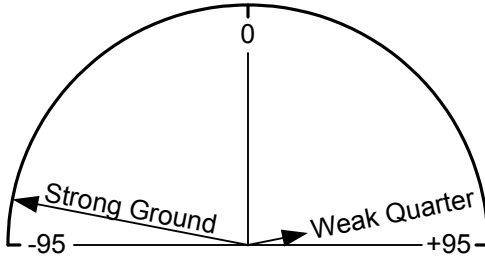

The detector will see both signals at the same time, and the combination of the two can be represented with a third vector as follows:

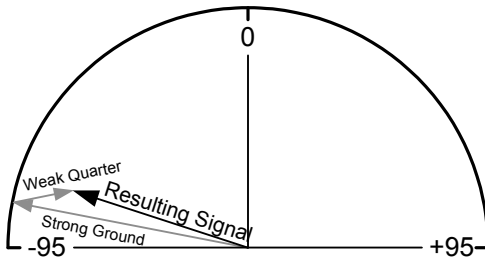

The resulting signal appears to be a fairly strong ferrous target instead of a quarter. This is the downfall of the old TR-discriminator designs. Fortunately, since the VDI response for ground is usually far away from the response of desirable targets, there are ways to deal with it. In a modern VLF motion discriminator, the receiver determines what part of the signal is the ground response and, using special filter techniques, normalizes the whole VDI scale to the current ground signal, resulting in the ground signal being ignored. Graphically, this looks like:

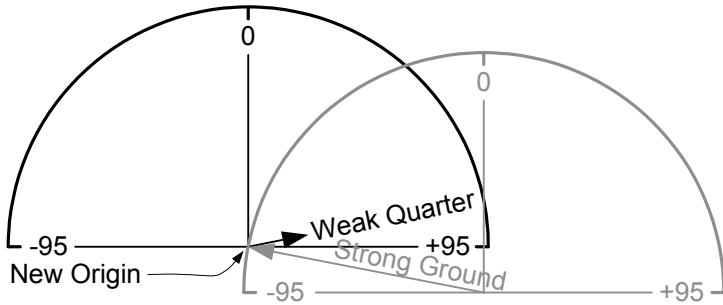

Any error in the ground balance point can result in an error in the target VDI response so it's important to maintain a decent ground balance point.

Ground Tracking

In order to better handle variations in ground mineralization, many detectors now incorporate automatic ground tracking (White's uses the term *AutoTrac*[®]). The detector attempts to determine what part of the signal is due to ground and continuously track the phase and strength of that signal, and eliminate it. One trick is to limit the range of VDI's for normal ground (the grayed area in the VDI scale) and consider anything else a target. This works for most soils, with two caveats.

Besides "normal" ground mineralization, some areas contain rocks or small pockets consisting of material with slightly different mineralization than the surrounding ground. The difference in VDI between these anomalies and the surrounding ground isn't enough to consider them a true target, but they are small enough to act like a target to the detector's ground filters. These so-called "hot rocks" can create annoying responses in many detectors.

Another situation concerns soils with significantly conductive salts. A pure salt response lies all the way in the non-ferrous region of the VDI scale, roughly in the midst of foil. Some salt-water beaches are close to having a pure salt VDI, while other beaches include black sand mineralization that creates a

composite VDI that can land anywhere between pure ferrite (VDI = -95) and pure salt. Other areas, like fertilized fields with residual salt ions, can also have a composite ground response. Many deserts have a layer of surface salts that have been leached from the soil; this is generally not a problem as long as it is dry.

Frequency

Metal detectors are produced using a wide range of transmitted frequencies, from 1kHz up to around 100kHz, though the vast majority fall in the VLF range of 3kHz - 30kHz. Low frequencies usually favor thicker targets and metals of higher conductivity, while high frequencies favor thin and low-conductive targets.

Interesting Experiment: Thickness matters because of a phenomenon known as *skin effect*. To demonstrate this, cut several identical flat squares (say, 1"x1") of aluminum foil. Test the VDI response of a single square, and see how the VDI varies as you stack more squares (tightly) together.

Low frequencies also do a better job penetrating ground mineralization, including salt. High frequencies tend to generate stronger ground and salt signals which can limit the ability to distinguish weak targets. Obviously, when trying to detect thin low-conductive targets (like nuggets and jewelry) in harsh ground (like wet salt sand or black sand) there are competing frequency requirements, so a compromise is necessary. With the ability to run 3 simultaneous frequencies or any one of them individually, VX³ has the ability to deal with a wide variety of conditions.

Turn On & Go

VX³ is highly programmable and includes several factory preset programs which provide good overall performance and allow a new user to quickly start hunting.

1. Press **ON/OFF**: *VX³* briefly displays a start-up screen, and after 2 or 3 seconds goes straight to the search screen:

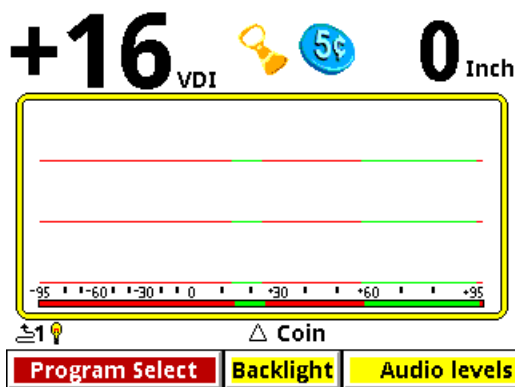

2. At the bottom of the screen is the Live Control Bar, which gives you direct access to most of *VX³*'s settings. The first item is **Program Select**; if you highlight this and press **ENTER** you will see a pop-up selector listing all the available programs:

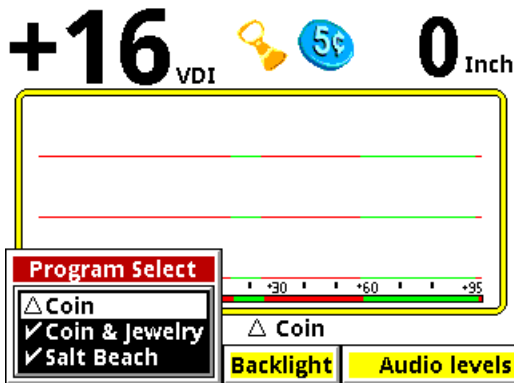

Select a desired program, pull the Trigger, and VX³ is ready to start hunting.

Programs and Memory

VX³ has 8 preset factory programs:

- **Coin** - Accepts most common US coins, including nickels. Most other VDI regions, including where most jewelry is found, are rejected.
- **Coin & Jewelry** - Accepts most common coins, along with rings and jewelry.
- **Salt Beach** - Coin & Jewelry using salt subtraction mode.
- **Relic** - Mixed mode, no Tone ID, no VCO.
- **Prospecting** - All-metal mode optimized for nugget hunting.
- **Deep Silver** - Optimized for deep silver.
- **Hi-pro** - Advanced Coin & Jewelry.
- **Demo** - Extra program for whatever you want. Factory settings for this program are weak, intended for in-store demos.

These programs are designed for good performance under most conditions and provide an excellent starting point. However, ground conditions vary considerably, so some adjustments may be necessary. Changes to factory programs are automatically

saved to memory and recalled each time VX³ is powered on. Restoring factory settings is covered in Chapter 7.

Ground Balance

VX³'s automatic ground balance system has a fast-track mode that attempts to balance the system to soil conditions within 20 seconds of turn-on. If you do not begin searching within 20 seconds or the ground is unusually trashy, VX³ may not fast-track correctly and you may want to do a manual ground balance:

- Squeeze/hold the Trigger, then press/hold **ENTER**.
- Pump the search coil over the ground (1-12 inches) until the background hum becomes steady (usually 4 to 6 times). Make sure you do this over an area free of targets.
- Release **ENTER**, then release the Trigger, and begin searching.

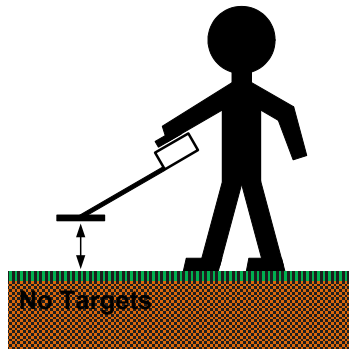

Tip: If you release the trigger *before* releasing **ENTER**, VX³ will lock the screen to pinpoint mode. Simply pull the trigger twice to resume searching.

This manual ground balance sequence can be done at any time during normal search. Once the initial ground balance is completed, VX³ will automatically track to most typical ground mineral changes.

Tip: If VX³ seems to have an erratic audio only when sweeping the search coil on the ground, check the ground balance.

Electromagnetic Interference (EMI)

EMI can be a problem with any wide-band metal detector, whether a multi-frequency VLF or a pulse induction design. VX³ includes a frequency offset to help deal with this. Select the **Transmit Frequency** item on the Live Control Bar to access the **Offset** control:

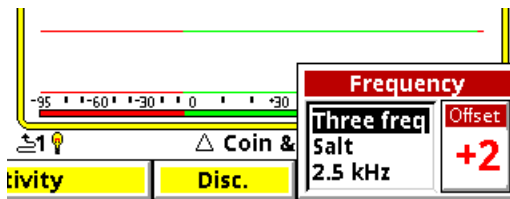

There are ± 5 increments of frequency offset; with the search coil held in the air, find the one for best stability.

Tip: EMI is easiest to hear in pinpoint mode (trigger pulled).

Tip: If VX³ continues to have erratic audio with the search coil held in the air, reduce the RX Gain.

Menus & Controls

VX³ has a number of configuration settings with 2 ways to access them:

- Live Control Bar — Live-search settings
- Menus — All settings, suspends operation

When the **MENU** button is pressed during normal search the Main Menu appears. We will cover all the menu settings in subsequent chapters.

Tip: Press **ZOOM** to change the font size of the menus.

Live Control Bar

You may want to quickly change settings while searching. The Live Control Bar is displayed at the bottom of the Search screen and its items are accessible via the left/right arrow buttons. When a Live Control item is selected (using the **ENTER** button), a small control box pops up with one or more individual controls:

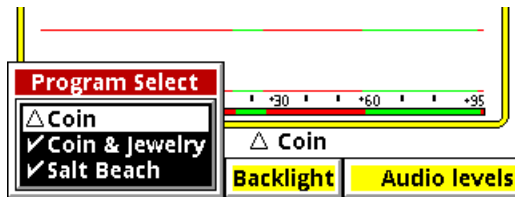

Any available setting in the Live Control Bar performs the same function as any like-named setting in the menu, but the live controls can be adjusted while the detector is in normal operation. For many of the Live Control items, you can press the **VIEW** button to access menus with additional settings and controls. Accessing these menus suspends the search operation of *VX³*.

Tip: Press **VIEW+DN** and **VIEW+UP** to hide or expand the Live Control Bar.

Main Menu

While the Live Control Bar and its menus contain all of *VX³*'s configuration settings, they are rather spread out. The Main Menu pulls all the settings together in one easy-to-navigate linear list. The Main Menu can be accessed by pressing **MENU** from the Search screen. To exit back to the Search screen, simply pull the trigger switch. When you re-enter the Main Menu *VX³* will remember where you were last, even if after a power down.

Tip: Press **MENU+** + **◀** to quickly collapse levels of the menu tree.

Controls

VX³ uses a variety of different interface controls such as sliders and radio buttons. Most of them are very similar to those found in computer graphical interfaces so they will be familiar to many users.

VX³ Displays

VX³ has 2 display modes which are controlled by the position of the trigger switch:

- Trigger neutral — Normal Search
- Trigger forward — All-metal pinpoint (no SAT applied)
- Trigger pulled — All-metal pinpoint (no SAT applied)

This section briefly describes the modes and their screens. Chapter 5 has a more detailed discussion of display modes.

Search mode

Search mode is the normal display mode for VX³ and shows a 3-frequency SpectraGraph¹:

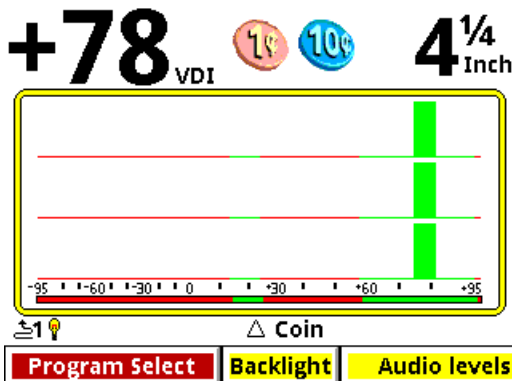

1. Programs which run in single frequency mode will display a single frequency SpectraGraph.

Along the top of the screen are the VDI number, icons, and depth. The majority of the screen consists of the SpectraGraph display, which provides real-time information on the target's VDI. See Chapter 5 for more information on how to read this display.

Below the SpectraGraph is the Status Line, which contains icons for the status of wireless headphones and backlight. In the middle of the Status Line the name of the active Program is displayed, and is occasionally overwritten by the ground tracking status.

At the bottom of the Search screen is the Live Control Bar which gives instant access to the most common settings while VX³ is operating.

Pinpoint mode

Pinpoint mode places VX³ in an all-metal mode and displays the Pinpoint screen:

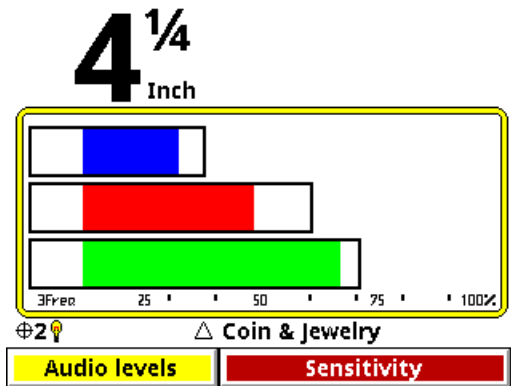

Again, this screen has the depth (but no VDI or icons), Status Line, and Live Control Bar. The Pinpoint display consists of 3 horizontal moving bars² which give the relative signal strengths of the three frequencies. This can be used to precisely pinpoint the target, and to see which frequency is giving the strongest

2. Or just one bar, for single frequency operation.

response. See Chapter 5 for more information on how to read this display.

Tip: To lock VX³ in Pinpoint mode simply flip the trigger switch forward.

VX³ Audio

VX³ supports a built-in speaker, plug-in headphones, and White's proprietary wireless headphones. Headphones are highly recommended as they help block out ambient noise, making it much easier to discern the deeper target responses. If you purchase the optional wireless headphones for your VX³, see Chapter 8 for connect instructions.

Metal Detecting Basics

There are many excellent books available that cover the hobby of metal detecting, and this manual cannot possibly do justice to all the aspects of the hobby. Ask your dealer to recommend a good introductory book. We will, however, touch on a few important topics.

Where to hunt

The basic rule of location is: the older the better. Old homes, home sites, schools, parks, swimming holes, and picnic areas can all yield great finds. However, "old" can also mean heavily used, which can result in a lot of accumulated trash. The best sites are those that have been "lost" or unused for decades.

Besides "old," there are places which are constantly getting replenished. With high gold prices, hunting for jewelry at beaches can be very profitable, especially if it includes stones. At parks and recreation areas, people often lay items on the ground while they play sports, then lose or forget them.

Permission

This is *CRITICALLY IMPORTANT!* Over the years, a small minority of inconsiderate detectorists have, in some places, created a negative image for the hobby (see the *Treasure Hunter's Code of Ethics* on the back cover of this manual). Do your part to maintain a positive image: *ask permission*.

Private property always requires permission. Approach the owner in a professional manner; some detectorists even make up business cards. Be willing to offer the property owner a portion of the finds, especially if it's a really choice site you're dying to hunt.

In many cities, homes have easements (the grass strip between a sidewalk and street) which technically belong to the city but are kept up by the homeowner. Assume it belongs to the homeowner, and don't hunt these areas without their permission.

Public lands have mixed access. National Parks are absolutely **OFF LIMITS** to metal detecting, and Park Rangers can confiscate your detector and even your vehicle. Don't even try! State parks vary considerably, depending on the state and/or the type of park. The best approach is to check with the Ranger Station responsible for the park.

Local parks and schools are usually open to detecting, though some localities may require you to register. Find out what the local laws are.

Detecting fundamentals

When you arrive at a hunt site, use your best intuition (and, hopefully, research) to identify the most likely areas for good finds. Often a site will be too large to cover 100% so you need to narrow it down. If you are just learning, don't be concerned with patterns, just walk around and hunt. As you get proficient with your detector and want to improve efficiency, you can mentally grid off areas and hunt them in a back-and-forth pattern.

Sweep the coil from side-to-side, with a ~3-4 foot swath, at a rate of 1-2 seconds per sweep. Keep the coil parallel with and close to the ground during the entire sweep; if you sweep with a “pendulum arc” (lifting the coil at the ends of the sweep) you will not only miss targets but also cause the AutoTrac to err. Some detectorists rub the coil directly on the ground, though bare dirt and gravel can eventually wear through the plastic (most coils have available snap-on covers). Overlap each sweep by 50% to ensure the best coverage of deep targets.

If you are hunting in a typical discriminate mode, listen for an accepted target beep; stop and double-check the spot, paying closer attention to the SpectraGraph response. If it appears to be a good target, move the coil off to the side of the target location, pull the trigger switch to enable pinpoint mode, then move the coil back over the target and use the all-metal audio response to determine exact location.

Use a proper digging tool and learn good plugging techniques to extract the target, or learn how to “pop” targets. When you are done there should be no trace that you dug anything. Haul out all trash that you find; many detectorists keep a small container of trash with them to show off the benefit they provide to the community, especially useful if a policeman stops by to ask why you are digging holes in the park.

Research

What you get out of metal detecting largely depends on what you put into it. Half the fun of detecting is doing historical research on the area you live in and learning where people used to gather and where things used to be. Visit museums and historical societies, and look for old maps and photographs. Get out and talk to people and, most of all, have fun!

Basic Settings

This chapter covers some of the basic settings of *VX³* including sensitivity, discrimination, audio, and ground balance. It does not cover any settings which alter the fundamental operating mode of the detector. See Chapter 4 for operating modes.

The settings covered here are all accessed from the Live Control Bar, by highlighting the item of interest and pressing **ENTER**:

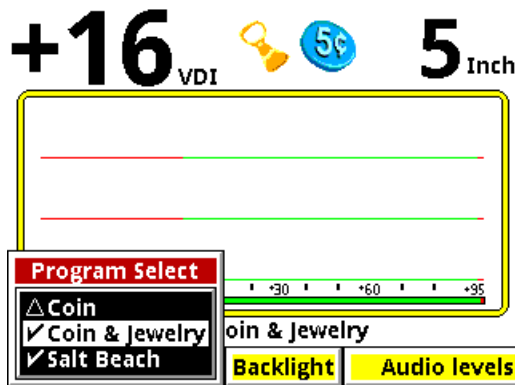

All programs are set up with the same Live Control Bar layout for consistency:

Programs • Backlight • Audio • Sensitivity • Disc. • Frequency • Tracking • Filters

Each Live Control pop-up contains the most common settings for each category. The pop-up settings for each item in the Live Control Bar usually has a subset of what is found in the Main Menu. However, when a Live Control item is selected, pressing the **VIEW** button will access a more detailed menu which has everything found in the Main Menu:

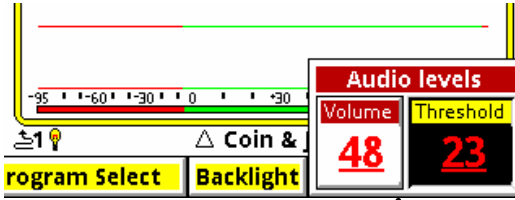

[press VIEW]

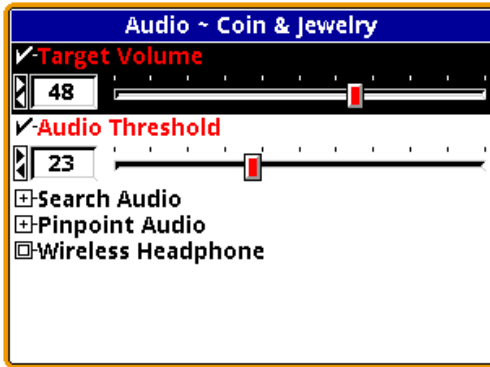

Tip: The **Live Control Bar** is the collection of buttons across the bottom of the screen. Each button is called a **Live Control Item**. Each item consists of one or more settings. Press **VIEW** for any **Live Control Item** to access a **Menu** for that item. Keep in mind that the detector is “live” while accessing the **Live Control Bar**, but is suspended when you enter a **Menu**.

Programs

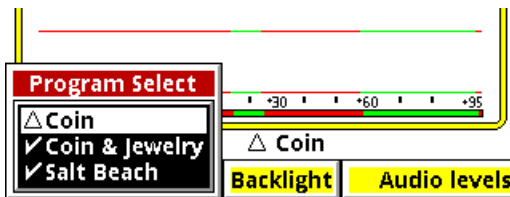

This was briefly covered in Chapter 2. *VX³* has 8 preset factory programs:

- **Coin** - Accepts most common US coins, including nickels. Most other VDI regions, including where most jewelry is found, are rejected.
- **Coin & Jewelry** - Accepts most common coins, along with rings and jewelry.
- **Salt Beach** - Coin & Jewelry using salt subtraction mode.
- **Relic** - Mixed mode, no Tone ID, no VCO.
- **Prospecting** - All-metal mode optimized for nugget hunting.
- **Deep Silver** - Optimized for deep silver.
- **Hi-pro** - Advanced Coin & Jewelry.
- **Demo** - Extra program for whatever you want. Factory settings for this program are weak, intended for in-store demos.

Notice that **Coin** is preceded by a “Δ” symbol whereas the other programs have a “✓” symbol. The “✓” symbol means a program has not been modified, whereas a “Δ” symbol indicates changes have been made. At any time you can easily restore a program to its factory settings; this is covered in Chapter 7.

Tip: Program changes are automatically saved when VX³ is turned off. If you remove the battery pack instead of pressing the **OFF** button, then program changes will not be saved.

Note that changing the Program from the Live Control Bar is a live action and can be a little sluggish if you are trying to scroll from Coin down to Hi-Pro. Press **VIEW** to bring up the non-live menu which is much faster to scroll through.

Backlight

VX³ uses a transflective display that has good visibility in direct sunlight without the backlight. In shade or low sunlight you may need to turn on the backlight. Backlight brightness can be set from 1 to 20. Keep in mind that more backlight draws

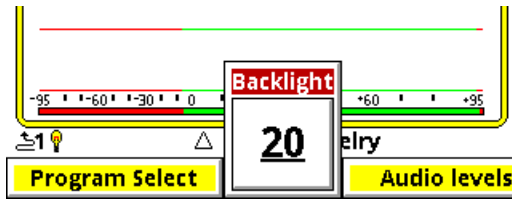

more power, so for maximum battery life try to keep the backlight to a minimum.

Tip: Press/hold the ON/OFF button for ~3 seconds to quickly set the backlight level to 20. VX³ will not turn off.

Sensitivity

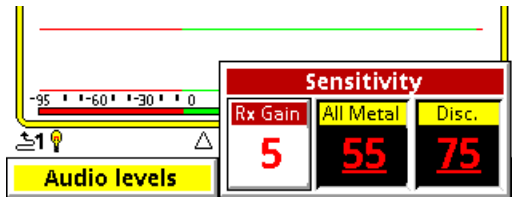

Once you select a basic program you may need to adjust the sensitivity settings. Most of the VX³ programs are set up with nominal sensitivities, but the Hi-Pro program is set up a little hotter.

Most users believe sensitivity should be run as high as possible. In some cases this is true, but if you find the detector is noisy and falses a lot you probably need to turn it down. There are three primary sensitivity settings: Rx Gain, All Metal, and Disc.

Rx Gain

Rx Gain (sometimes called *preamp gain*) sets the gain of the receiver's input amplifier. In most cases, you want to set this as high as possible and still maintain stable operation.

Three things can limit the maximum gain setting. The first is external noise, such as electro-magnetic interference (EMI) including 50/60Hz mains and RF. EMI typically shows up as

Tip: VX³ uses induction-balanced loops which rely on a “null” between the transmit coil and the receive coil. The quality of the null may determine the point at which the detector overloads, especially when running high Rx Gain settings. Null quality varies loop-to-loop, so some loops may overload at lower gain than others.

erratic operation and noisy audio. Secondly, in highly mineralized ground excessive gain can cause the input amplifier to overload or operate at close to overload due to the large ground signal, limiting the available range for target detection. Finally, the quality of the loop null can also push the input amplifier toward overload. White's V-compatible loops are designed to minimize null limitations, but third-party loops typically have wide variances in the quality of the null which can require a lower Rx Gain.

EMI affects the lower end of the signal range, which more directly impacts target sensitivity. Both ground signal and loop null affect the upper end of the signal response range, which usually results in a quicker overload. Ground signal and loop null affect target sensitivity only so far as the Rx Gain must be reduced to prevent overload.

Tip: Always address EMI noise by first adjusting the transmit frequency offset. See the **Frequency** section for more info.

All-Metal Sensitivity

All-Metal Sensitivity (sometimes called *DC sensitivity*) determines the responsiveness of the all-metal channel. All target signals cause an all-metal audio response regardless of signal strength, but a higher all-metal sensitivity setting will increase the response rate to targets. This setting affects all-metal modes including pinpoint and mixed-mode, but does not affect normal discrimination mode. Setting this too high will make the all-metal audio chatter. See Chapter 4 for a more detailed discussion of audio responses.

Discrimination Sensitivity

Discrimination Sensitivity (sometimes called *AC sensitivity*) determines the responsiveness of the discrimination channel. This is a threshold level, so only target signals above the threshold cause a discrimination response. Setting this too high will cause noise and falsing in the discrimination audio. See Chapter 4 for a more detailed discussion of audio responses.

An important note about sensitivity: Many users assume that “more sensitivity = better depth.” However, most metal detectors are designed with more sensitivity range than can possibly be used in many areas. This is to ensure that maximum sensitivity can be achieved in the purest ground. In many areas, less sensitivity is better; a quieter audio allows you to hear deeper targets.

Audio

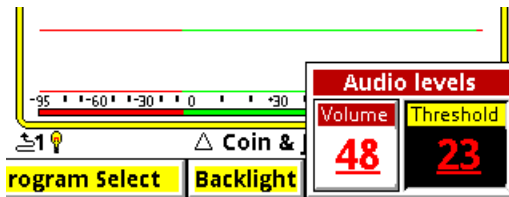

Volume sets the audio volume level for target responses (the beeps). **Threshold** sets the volume level for the threshold tone, which is the constant “hum” heard in the absence of a target. Both target & threshold volumes are applied to all the audio outputs: speaker, wired headphones, or wireless headphones. If, for example, you set the volume while using the speaker, then plug in a pair of headphones, you may need to readjust the volume for the headphones.

Discrimination

This is the method for setting up the discrimination pattern for VX³. The pop-up box lists all the VDI numbers from -95 to

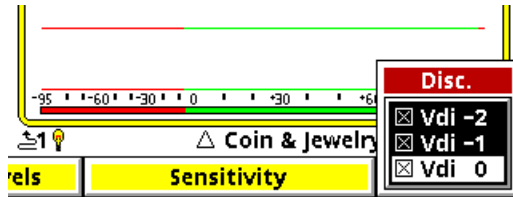

+95, each with a selection box. A box that has an ‘x’ enables that VDI response, an empty box disables that VDI.

Tip: Setting the disc mask for 191 VDI’s can be tedious. If you want to set a range of VDI’s to the same state select the first VDI in the range, press **ENTER+▼** to set the same value to subsequent VDI’s.

Bonus Tip: This works in either direction.

Frequency

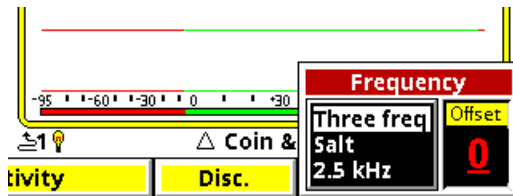

The only control we will cover in this chapter is **Frequency Offset**. See Chapter 4 for discussion about frequency modes. The **Frequency Offset** control provides slight offsets (± 5 steps) to the transmit frequencies and is useful for minimizing EMI from power mains and RF, and for minimizing interference from other detectors. In general, adjust the offset up or down to find the quietest setting.

The Live Control Bar makes finding the quietest offset easy. With the loop held in the air, pull/hold the trigger to enable pinpoint mode. EMI interference will be heard as repetitive audio noise, and the pinpoint bars will bounce around like this:

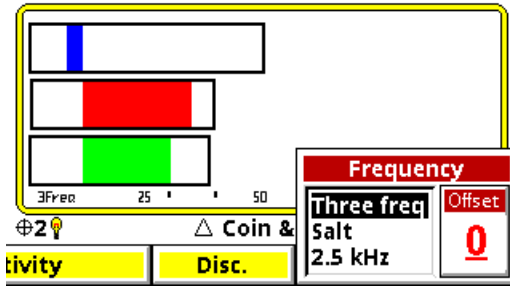

While continuing to hold the trigger, select **Transmit Frequency** and highlight the **Offset** box. Adjust the **Offset** to find the quietest setting. The pinpoint bars should be minimal and steady:

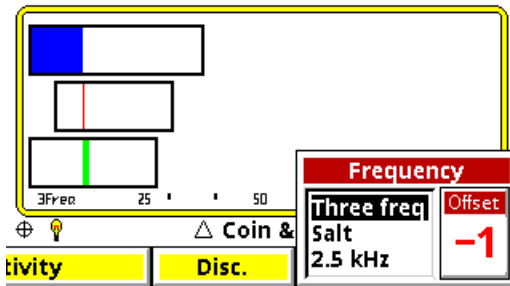

Release the trigger and you're set.

Tip: Be mindful of personal electronics you are carrying. There have been reports of cell phones causing EMI problems with detectors.

Ground Tracking

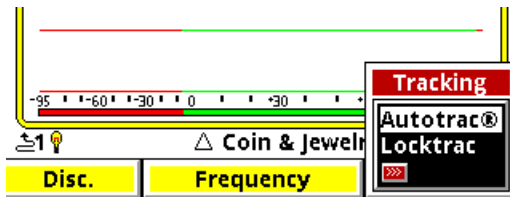

AutoTrac and **LockTrac** select between automatic and manual ground balance. AutoTrac is the default in most programs. Ground balance modes are explained in more detail in Chapter 4.

Filters

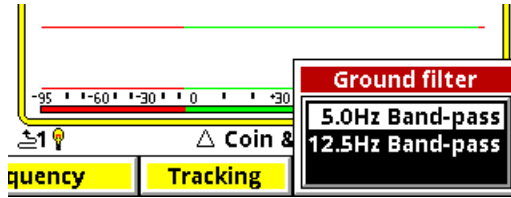

As presented in Chapter 1, modern VLF detectors use filters to separate the target responses from the ground response. Filters are also used to minimize EMI noise. The best filter to use depends on the strength of ground mineralization plus other factors. *VX³* offers two filters to choose from: a 5Hz filter for low-to-modest mineralization and 12.5Hz for more severe ground conditions. Filters and response speeds are explained in detail in Chapter 6.

Chapter 3 covered some of the basic settings of VX^3 , such as sensitivity and audio volume. These were adjustment controls which are used to alter the performance or user preferences. There are other settings which fundamentally alter the operation of VX^3 . We will refer to these as *mode* settings. Different mode settings might affect completely different aspects of the detector — such as frequency, tracking, and audio — so taken together they offer a tremendous amount of flexibility to the user.

While many settings are quickly available on the Live Control Bar, some of the mode settings require leaving the search screen and accessing the menus. Each item on the Live Control Bar has its own menu which can be accessed by pressing the **VIEW** button. Additionally, all modes and settings are available in the Main Menu, accessed from the Search Screen by pressing the **MENU** button.

Frequency

VX^3 is a 3-frequency metal detector, but it has the ability to run in other optimized frequency modes. The available modes are:

- 3-frequency normal
- 3-frequency salt compensate
- Single frequency 2.5kHz
- Single frequency 7.5kHz
- Single frequency 22.5kHz

The frequency selection menu in VX^3 looks like this:

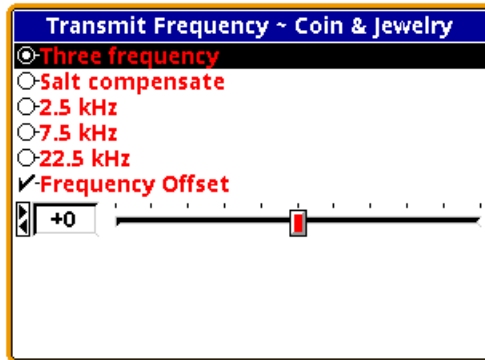

One reason for using multiple frequencies is that some targets respond better to certain frequencies than others. Targets that are thin and made of low-conductive metal — typical of most jewelry — respond better to higher frequencies, which is why many gold nugget detectors are designed to run at much higher frequencies than most other detectors. High conductive targets, especially those that are thick, respond better at lower frequencies. Also, ground mineralization has a weaker response at lower frequencies, resulting in better ground penetration in highly mineralized areas.

Three Frequency

The default frequency mode for most programs is standard **Three Frequency**. In this mode, *VX³* simultaneously transmits at 2.5kHz, 7.5kHz, and 22.5kHz. 3-frequency mode gives the best overall response to the broadest range of target conductivities.

In any frequency mode *VX³* will plot the VDI responses in the SpectraGraph screen and also calculate an overall VDI number for the target. In 3-frequency mode the results from at least two responding frequencies must agree in order to display the VDI number and generate a tone response. This helps minimize false positives.

Salt Compensate

Salt Compensate mode is the same as **Three Frequency**

mode, except that salt responses are subtracted out. This eliminates salt signals while still allowing *VX³* to track ferrous mineralization. This technique is only possible in multi-frequency detectors, which is a second reason to use multiple frequencies. The Salt Beach program uses this mode.

Trivia: White's DFX is always in salt compensate mode.

A small downside to salt compensate is that a narrow range of VDI's are notched out and targets in that range won't respond. The VDI for salt is around +4 to +5 which is normally the area for bits of foil. However, very small gold nuggets and some jewelry can also fall in this range, which is why *VX³* has the added option to run a normal 3-frequency with salt subtraction disabled. Some *V*-users have reported situations where the salt-compensate mode helps reduce EMI noise.

Single Frequency

With any multiple frequency detector, the total transmit power must be divided among the active frequencies. *VX³* offers the ability to transmit only one of its three frequencies. In single frequency mode, the transmit waveform is optimized to focus power to the selected frequency, resulting in slightly better depth but for a more narrow range of targets.

Trivia: The single frequency modes in White's DFX do not use optimized transmit waveforms.

Usually the VDI responses for targets vary with frequency, which means that a particular target will have completely different VDI numbers at each of the three frequencies. For example, a US silver quarter has the following raw VDI responses:

Frequency	VDI
2.5kHz	70
7.5kHz	85
22.5kHz	91

However, VX³ normalizes all VDI's to a common frequency. That common frequency is, for historical reasons, 6.592kHz, meaning the US silver quarter will have a normalized VDI response of 83 regardless of which frequency you choose.

The Deep Silver program uses the 2.5kHz single frequency mode, which responds best to silver coins and tends to penetrate mineralized soil better.

Tip: In single frequency modes, battery consumption is higher for 2.5kHz, and lowest for 22.5kHz.

Frequency Offset

This is not a mode, but rather an adjustment control. It was discussed in Chapter 3: *The **Frequency Offset** control provides slight offsets (± 5 steps) to the selected frequency(ies) and is useful to minimize EMI, especially when hunting near other detectors. In general, adjust the offset up or down to find the quietest setting.* One source of EMI that is difficult to deal with are electric fences, including invisible dog fences. It is best to try to have them switched off when hunting.

The frequency offset applies to all active frequencies. If you have a single frequency mode selected, then the offset shifts that frequency. If you are in a 3-frequency mode, the offset proportionally shifts all the frequencies.

When making offset adjustments, put VX³ in pinpoint mode (by pulling the trigger) and watch the pinpoint bars, like this:

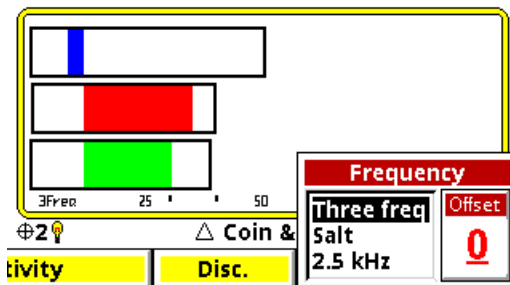

Along with the audio, the pinpoint bars will help you find the quietest offset. In some situations, you may not be able to find a quiet offset for all three frequencies at the same time. Pay attention to the pinpoint bars and see if one of the frequencies tends to run quieter than the others. If so, run in single frequency mode with the proper offset. A stable single frequency mode is usually better than an unstable 3-frequency mode.

Ground Balance

In Chapter 1 we briefly covered how ground balance works, and how automatic tracking can compensate for varying ground conditions. VX³ offers both automatic tracking (AutoTrac™) mode and the ability to lock the ground balance when needed (LockTrac).

Whether you are using AutoTrac or LockTrac, it's important to know how to check if VX³ is properly ground balanced. As you are hunting, test the ground balance occasionally using these steps: lift the loop a foot off the ground, pull the trigger to put VX³ in pinpoint mode, then lower the loop to the ground, making sure you are not over a target. In most ground, the pinpoint threshold level should remain constant as the loop is lowered to the ground. In the most severe mineralization, a lift-off effect can cause an abrupt threshold change in the last inch or so, and this is difficult to balance out.

AutoTrac®

AutoTrac mode automatically tracks the phase of the ground signal. This is the default ground balance mode for most programs and is the recommended mode except in certain conditions. When AutoTrac is enabled, you will see

<<< Tracking <<<
>>> Tracking >>>

occasionally pop up on the status bar whenever VX³ is changing its ground balance point. At start-up, it may say **Fast Track** instead.

LockTrac

There are some uncommon situations where AutoTrac does not work well. In extreme ground that has a lot of variability, or when a lot of trash targets are present, automatic tracking may result in excessive noise and tracking errors. High levels of EMI can also cause problems with automatic tracking. In these situations locking the ground balance at one value may provide better performance.

Keep in mind that when tracking is locked, VX³ will only be properly ground balanced for one type of ground. As the ground varies, there will be errors in the balance point, so there may be some compromise in depth or target ID. But LockTrac may allow hunting an area where AutoTrac does not.

Audio

The audio settings presented in Chapter 2 which were accessed from the Live Control Bar were limited to Volume and Threshold. The Audio menu also has three audio modes you can choose, with additional settings for each:

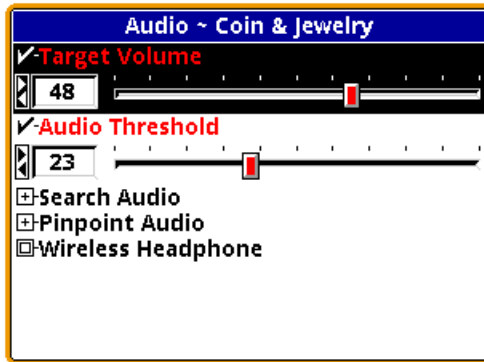

We will cover the modes first, then proceed through the various settings, not necessarily in the order of the menus. To help explain the audio modes, let's take a graphical look at the VX³ audio system, shown on the next page.

The **Rx Gain** setting (in the **Sensitivity** menu) is applied to

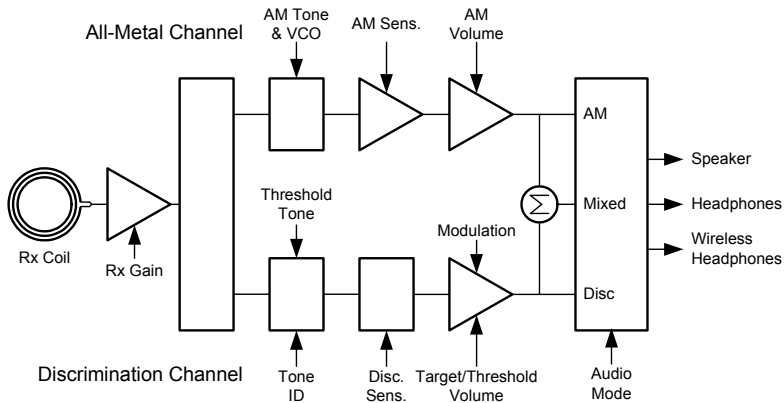

the raw input signal from the coil. The signal is then split into two processing channels, one for all-metal and one for discrimination, and these channels have their own audio responses. *VX³* has the following three search audio modes:

- All-Metal
- Discrimination
- Mixed-Mode

All-Metal mode produces audio only from the all-metal channel, and Discrimination mode produces audio only from the discrimination channel. Mixed-mode produces *both* the all-metal audio and discrimination audio. The audio can be sent to a standard speaker, a pair of plug-in headphones, or wireless headphones.

Note that the various settings apply only to one or the other processing channels (audio modes). It's important to remember which settings affect which mode, and that's not difficult once you understand what the settings do.

All-Metal Audio

The all-metal channel simply detects and indicates metal targets. It does not care what those targets are, nor does it attempt to tell you what they are. The all-metal audio channel is also used during pinpointing.

Tip: In the normal all-metal mode, SAT (self-adjusting threshold) is applied so if you hold the search coil steady over a target, the audio response will fade away on its own. In pinpoint mode, SAT is not applied so you can hold the search coil steady over a target and the response will remain steady.

In this channel, the **All-Metal Sensitivity** setting is basically an additional gain setting applied to the all-metal signal above and beyond the **Rx Gain** setting. The following graph shows a signal with both a low setting (black trace) and a high setting (gray trace). The higher sensitivity setting improves target signals, but it also increases the amount of audio noise and can make VX³ more “chattery.” This is especially true when EMI is present.

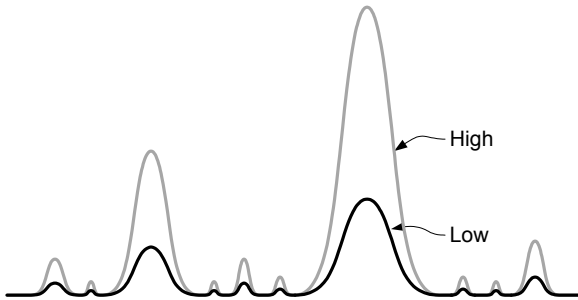

All-metal audio can be presented in one of two ways: VCO, and non-VCO. This selection is found at **Audio**→ **Search Audio**→**All Metal**→**VCO**:



If VCO audio is disabled then the all-metal audio response will be a fixed tone, and an increasing signal level creates an increase in its loudness:

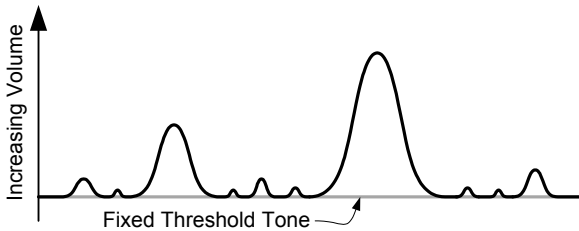

In other words, as the search coil is passed over a target, the all-metal audio will begin at a low volume and progressively rise in *loudness* as the target signal gets stronger, peaking when the search coil is directly over the target.

If VCO audio is enabled then an increasing signal level creates a rising audio tone or pitch:

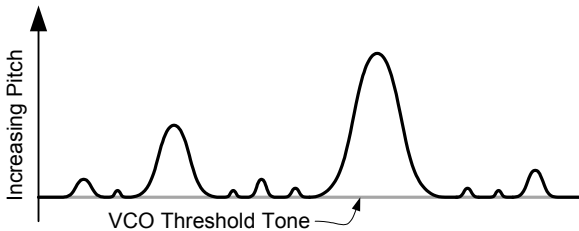

In other words, as the search coil is passed over a target, the all-metal audio will begin at a low tone and progressively rise in *pitch* as the target signal gets stronger. The highest pitch is achieved when the search coil is directly over the target (strongest target signal) and then the audio falls in pitch as the coil moves off the target. As with non-VCO audio, loudness also rises and falls.

Tip: The human ear is more sensitive to changes in pitch than to changes in loudness. Therefore, deep targets that produce only a very slight all-metal signal will be easier to discern using VCO audio. However, some people just don't like VCO audio or have hearing problems, so the option to turn it off is also provided.

Discrimination Audio

Unlike the all-metal channel, the discrimination channel does not treat all targets alike. Discrimination uses the VDI (phase) response of the target to determine how to respond. It is possible to assign different tones to different VDI responses, or to completely ignore targets with certain VDI responses.

Discrimination Sensitivity

In this channel, the **Discrimination Sensitivity** setting determines a threshold level above which you will hear target responses. In many detectors, this setting is simply called *Threshold*, but VX³ has separate adjustments for each channel. The following graph shows the relationship between the threshold level and the detection signal. Only detection signals that exceed the threshold level (shaded in gray) will become audible target signals. Otherwise, you will only hear the threshold tone.

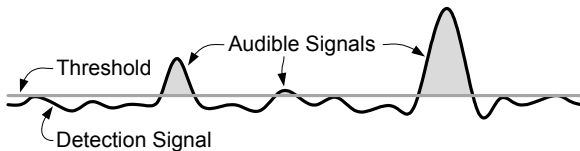

Increasing the **Discrimination Sensitivity** setting lowers the threshold, making VX³ more sensitive to weak target signals. Like **All-Metal Sensitivity**, this can also increase the amount of audio noise, and can make VX³ more chattery, especially when EMI is present.

Threshold Volume

The loudness of the discrimination threshold tone is set by the **Audio**→**Audio Threshold** control. Setting the threshold volume all the way to zero will result in silent-search (no threshold tone).

Target Volume

Audio→**Target Volume** adjusts the volume for the target response (that is, the target *beep*) in discrimination mode. The

Target Volume setting cannot be less than or equal to the Audio Threshold setting or targets will not be heard. VX³ attempts to maintain a minimum 8dB loudness separation between them. That is, if you try to increase the Audio Threshold setting too close to a corresponding Target Volume setting, the Target Volume will automatically increase in order to maintain an 8dB loudness difference.

Modulation

Audio→**Search Audio**→**Modulation** allows you to enable target audio modulation and to adjust its effect. Modulation is a technique where progressively deeper targets have a progressively weaker audio response (the *beep*). A shallow target produces a loud response, and a deep target produces a soft response. If modulation is disabled, then VX³ attempts to produce the same response loudness regardless of target depth.

With modulation enabled, you can also adjust the **Range** setting, which affects the strength of the modulation. A low setting makes shallow and deep responses more similar in loudness, and a high setting makes the modulation more pronounced.

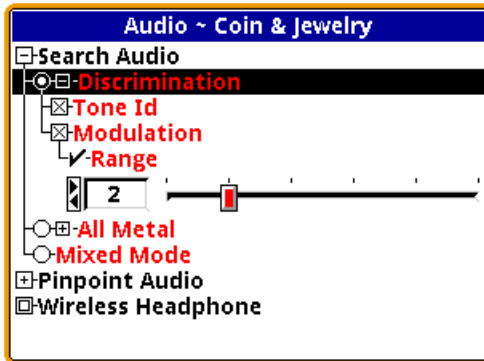

Tip: Modulation is most effective when you want to distinguish between deep and shallow targets of similar type. For example, if shallow coins are likely to be clad and deep coins are likely to be silver, then modulation will give you that information in the audio response.

Tone ID

Any modern discriminating detector has at least a rudimentary audio method of distinguishing accepted targets from rejected ones. This may be as simple as an audio response for accepted targets and no audio response for rejected targets. More advanced detectors have a tonal identification system where different tones represent different target ranges (phase responses).

VX³ has the ability to produce a different tone for each VDI number. But it can also produce a simple beep/no beep audio for those who don't want the complete tone ID system. If the **Audio→Search Audio→Tone ID** selection is unchecked, then all accepted targets will respond with a single tone. If it is checked, then the target response will use progressively higher tones for increasing VDIs.

Mixed-Mode Audio



Without mixed-mode, you can hear either the all-metal audio or the discrimination audio. The all-metal channel doesn't tell you anything about the quality of a target; the discrimination channel only signals on accepted targets, and rejected targets cause a null in the audio. Weak targets below the discrimination threshold produce no discrimination response.

Mixed-mode lets you hear both audio channels. The advantage is that you can hear the responses of all targets, even those

that are below the discrimination threshold. This can help in target separation, especially in trashy areas, and can also help in pinpointing targets. On the other hand, the increased target responses can be overwhelming and create audio fatigue, especially for new users.

Mixed mode equally applies both the all-metal audio and the discrimination audio to the speaker or headphones. In the absence of targets, or for targets below the discrimination threshold, the mixed-mode audio output will be the all-metal response, and you will hear the all-metal threshold plus the all-metal response of rejected targets. When an accepted target is detected, the discrimination audio will take over and you will hear the discrimination tone for the target; for a rejected target you will still get an audio null. Due to a hardware limitation, both audios cannot sound at the exact same time, so as the discrimination audio comes in, the all-metal audio cuts out. This is illustrated below.

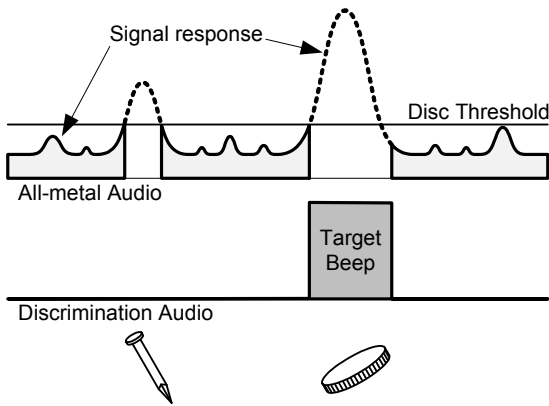

When mixed-mode is selected, there are no additional settings. By default, Tone ID is on, modulation is set to 1, and all-metal VCO is on.

Pinpoint Mode

Although technically not one of the three major search audio modes, pinpoint audio could be used for searching if you

pull and hold the pinpoint trigger switch or flip it to the forward position. Pinpoint audio is identical to all-metal audio with one exception: normal all-metal mode has SAT applied to it, and pinpoint does not. That means the all-metal channel requires loop motion or the target will get “tuned out,” but pinpoint does not require loop motion.

Pinpoint audio has only one option, **VCO**, which is the same as with the all-metal search mode.

Discrimination

A primary feature of practically all detectors since the 1970's has been discrimination. *VX³* is no different. Discrimination, of course, allows us to accept or ignore certain targets based on their phase (or VDI) response. In analog detectors, this is accomplished with a knob that sets the threshold point of discrimination; everything below the threshold is rejected, and everything above is accepted.

Modern digital detectors take discrimination to a higher level, allowing the user to accept and reject narrow VDI regions. *VX³* has a discrimination resolution that allows individual VDI number to be accepted or rejected. The Discrimination menu is:



Unlike the Disc entry on the Live Control Bar, the Disc menu includes the icons assigned to each VDI, making it a little

easier to see what kinds of targets you are accepting and rejecting. Keep in mind that these are only potential target types, and that many targets (especially jewelry) can have broad ranges.

Tip: There are 191 VDI numbers, and setting each one individually can take a long time. There is a short-cut: when you press the **ENTER** button to check or un-check a VDI, continue holding down the **ENTER** button, then press the **▲** or **▼** button to rapidly set a range of VDI's to the same setting.

The icons that are assigned to the VDIs depend on the program selected. There are three pre-defined icon tables for **Park**, **Relic**, and **Prospecting**. These are shown on the next page. In the factory programs, the **Park** icon set is used for all programs except Relic and Prospecting.

Speaker and Headphones

VX³ provides three ways to listen to audio:

- Speaker
- Plug-in headphones
- Wireless headphones

When you plug in a set of headphones, the speaker is disabled. When wireless headphones are enabled and connected, the speaker is disabled but plug-in headphones are still enabled, allowing two people to use headphones for training purposes. Basic wireless headphone connection was covered in Chapter 2; see Chapter 8 for more detail.

Preset Icon Tables

Park		Relic		Prospecting	
-97 to -57		-97 to -57		-97 to -57	
-56 to -27		-56 to -27		-56 to -27	
-26 to -1		-26 to -1		-26 to -21	
+0 to +12		0 to +17		-20 to -1	
+13 to +16		+18 to +23		0 to +16	
+17 to +24		+24 to +37		+17 to +24	
+25 to +50		+38 to +40		+25 to +50	
+51 to +54		+41 to +44		+51 to +57	
+55 to +57		+45 to +55		+58 to +75	
+58 to +68		+56 to +60		+76 to +80	
+69 to +75		+61 to +70		+81 to +86	
+76 to +80		+71 to +75		+87 to +90	
+81 to +86		+76 to +78		+91 to +94	
+87 to +90		+79 to +82		+95	NONE
+91 to +94		+83 to +86			
+95	NONE	+87 to +90			
		+91 to +93			

VX³ has two display screens which depend on the position of the trigger switch:

Search screen: Trigger neutral

Pinpoint screen: Trigger pulled or forward

Search screen

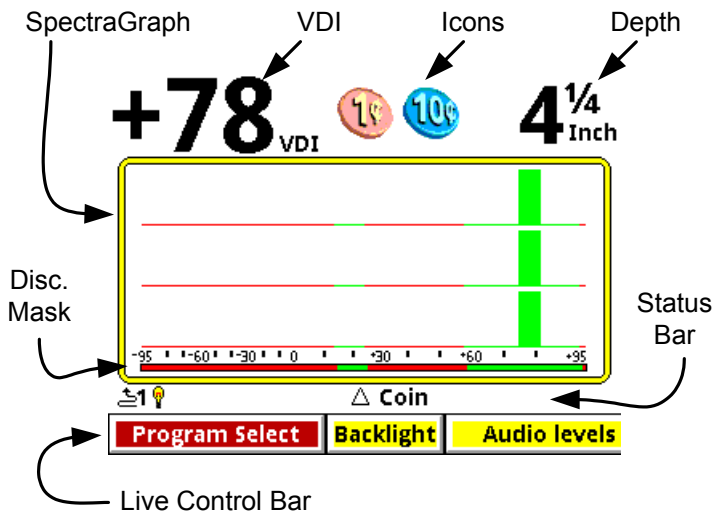

The Search screen has several regions as labeled above. The central part of the screen is the SpectraGraph which plots the target response in terms of signal strength versus VDI. In the screen shown, there are three of these responses, one for each frequency. The top region shows the (composite) VDI readout, icons, and depth. The “status bar” shows a few status icons and other information. The Live Control Bar has been covered in previous chapters.

VDI

As the loop sweeps over a target the received target signal rises, peaks, and then falls. Ideally the VDI¹ of a “well-behaved²” target is independent of signal strength, but in reality weak signals will show errors in the VDI. For that reason, the most accurate VDI will occur at the peak of the target signal response. Therefore, as you sweep over a target (especially with a slow sweep) you may see the VDI rapidly change before it locks onto a final value:

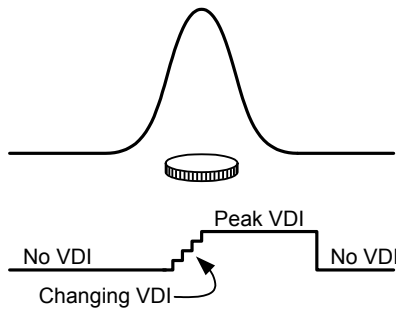

In three frequency mode the VDI is a composite number based on the peak VDI readings of at least the two strongest responding frequencies. For that reason, you may occasionally notice that the VDI number does not exactly match the Spectra-Graph response, especially for a weak frequency. In single frequency mode the VDI is obviously taken off the one active frequency.

Since VDI accuracy diminishes with depth, deep targets can produce erroneous VDIs. High ground mineralization can also shift VDIs; again it gets worse for deep targets. This is where experience determines whether you pass over a 1914D Lincoln because the VDI looked like a zinc cent. The best way to learn your detector is to dig a lot of targets, paying close attention to exactly what the detector was telling you before you dug it up.

1. Visual Discrimination Indicator; see Chapter 1.
2. Such as a flat round disc-shaped homogeneous metal target laying horizontally.

Icons

Icons are simply a pictorial representative possibility of the VDI number. Because many different targets can overlap in their VDI numbers, sometimes two icons are presented as possibilities. For example, pull tabs and gold rings often share VDI ranges. As you learn *VX³*, you should find yourself paying less attention to the icons and more to the VDI number and the SpectraGraph bars.

Depth

The depth readout in normal search mode is only an estimate. With any detector, depth is calibrated for particular targets, usually certain coins, and many other targets may show a large error. For example, ring targets can be deeper than their displayed depth, and shallow stainless steel may display a deeper reading.

Furthermore, the depth displayed in search mode is a “live” depth reading where the signal has passed through several stages of filters. Live depth can vary with sweep speed, typically reading deeper as you sweep slower. Pinpoint depth is based on a static signal and is usually more accurate. Use the live depth reading with a degree of skepticism, and the pinpoint depth as more realistic.

SpectraGraph

The SpectraGraph[®] display is a progression of White's SignaGraph[®] which was used in XLT and DFX. Besides the addition of color, SpectraGraph plots the response of each frequency separately, so you can see individual variations in the VDI responses, amplitudes, and decays. The highest frequency is always on top. Obviously, in a single-frequency mode only one frequency is plotted.

SpectraGraph plots target signal strength versus VDI. Note that the VDI axis is not linear; the negative half (-95 to 0) is compressed compared to the positive half (0 to +95). This is

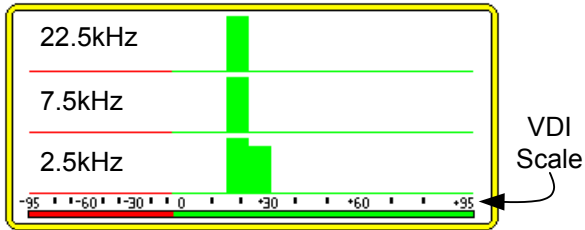

because we are mostly interested in what goes on in the positive half, where the majority of good targets respond. The negative half is mostly where iron falls.

Also note that each response bar is 7 VDI points wide. This means that the bars don't represent a precise VDI number, but rather a small range of numbers. Because the negative side of the graph is compressed, bars in the iron region will appear to be more narrow, though they are still 7 points wide. In some cases a target response will exhibit a VDI response that exceeds 7 points, and the SpectraGraph will show this as more than one bar. This can be seen in the example above for the 2.5kHz response.

The "disc. mask" is the portion of the SpectraGraph region which shows the current discrimination mask. In the following example (Coin & Jewelry), everything below -5 is red (rejected), and everything at or above -5 is green (accepted). The response bars in the SpectraGraph are color-keyed to the disc mask. When you edit the discrimination pattern (see Chapter 3) the disc. mask and response bar colors will reflect those changes.

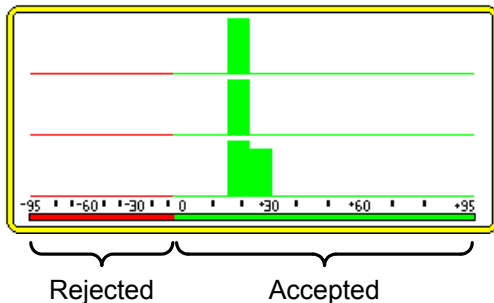

Ideally all targets would have tight responses that are repeatable. The closest you can get to that is to air test targets 3-4' from the coil, and that is not a bad start to learn how different targets respond. However, just like we discussed with VDI numbers, as a given target moves farther from the coil, its response gets weaker and exhibits shifts and spreading in the graph response, and is not as repeatable. This gets even worse in mineralized ground.

Even with three frequencies and SpectraGraph, interpreting target responses can be tricky business. Experience is the best teacher (learn by digging lots of targets!), but there are a few tricks we can discuss.

Smearing

A “well-behaved” target will have a response that closely follows a constant VDI as the loop is swept over it. The vector response for such a target would start at zero, follow a straight line on a constant VDI up to the signal peak (where the loop is centered on the target), and return to zero as the loop is moved away. It will graphically look like³:

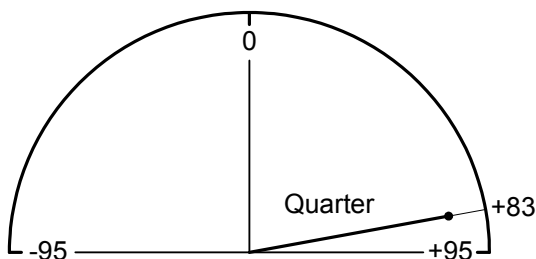

This might represent a somewhat shallow quarter, and would have a SpectraGraph response with nice tight bars. Note the black dot, which indicates the peak signal strength; this is also the point where the VDI number is calculated. The same quarter buried deeper begins to exhibit a small amount of curvature in the vector response:

3. See Ch. 1 for background info on vector responses.

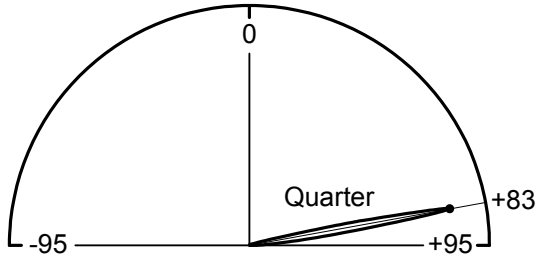

Now the signal response starts at zero and still reaches approximately the same peak point (perhaps resulting in the same final VDI), but shows some curvature on the way up and on the way back. Because the SpectraGraph response is taken from the whole of the signal response and not just the peak, this can result in a “smearing” effect in the bars, as shown here:

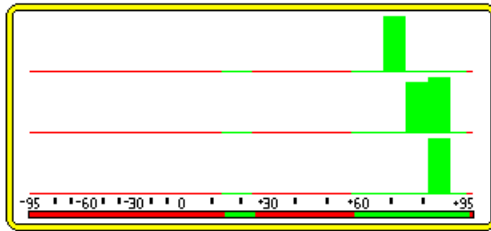

Pay attention to the amount of smearing compared to the depth and the composite VDI number. If it seems like it might be a good target that’s just deep, then that is exactly the sort of target you want to dig.

Trash targets, especially iron, can exhibit significant smearing. To illustrate why, let’s look at the vector response of a bottle cap:

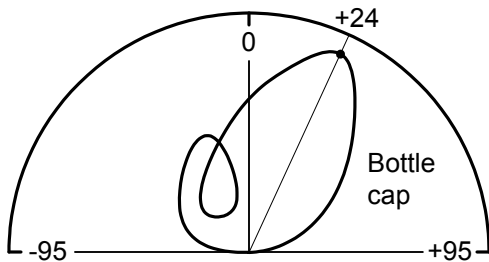

As the loop is swept over the bottle cap, the phase response varies wildly. This will not only result in smearing of the SpectraGraph plot, but will also cause it to jump around significantly before it locks on to a final reading. Such a final reading might look like:

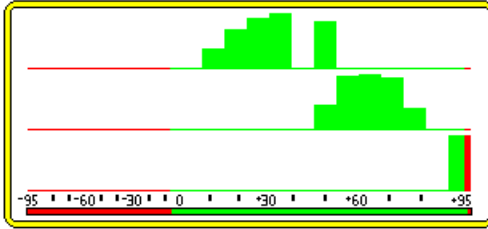

Notice the peak point from which the composite VDI is calculated; it is clearly in the non-ferrous (good) region, even though bottle caps are typically steel. The point of all this is to pay close attention to what *VX³* is telling you *all the time*, not just the locked-in response. When you initially detect a target, go back over it with deliberately slow sweeps and watch the dynamic responses.

Unaligned bars

Because *VX³* normalizes the VDI responses of each frequency, the SpectraGraph bars tend to be vertically aligned. In some cases they are skewed, indicating a possible “problem” with the target. For example, in the prior SignaGraph response of the bottle cap, the bars have a very poor correlation, caused by the ferrous properties of the bottle cap.

However, like everything else, there is no hard-and-fast rule at work here. Mineralized soil can also affect frequencies differently such that deeper targets have unequally shifted phase responses. In the “deep quarter” SpectraGraph on the previous page, there is some skewing of the bars. Again, look at the dynamic responses, and also pay attention to the repeatability of the target responses. If every sweep across the target produces a different response, then it is questionable (but if it is very deep, consider digging it!).

Mixed response

Sometimes you will see response bars that include both green and red:

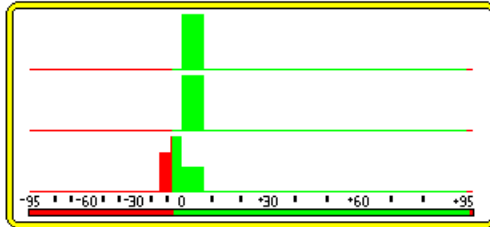

This simply means that the target is on the edge of the rejection/acceptance point. Because each bar is 7 VDI points wide a target that is accepted can still show some red in the response bar.

In the above graph, notice that the 22.5k and 7.5k frequencies are nicely aligned, and the 2.5k response is both slightly skewed and broader. This generally indicates that the 2.5k response is less reliable, as it had trouble “locking” to a particular VDI.

Wrap-around

Occasionally targets will “wrap around” between +95 and -95. This can be due to a high conductive target (a silver dollar, we hope) getting shifted upward by mineralization. Or, on the down side, it could be due to a “cold rock,” a mineralized rock that is below the ground balance point. Again, paying attention to how other targets are behaving⁴ will give you a strong clue as to which of these is more likely.

Status Bar

The final part of the screen to discuss is the Status Bar. To the left is a group of icons which depict (1) the trigger switch mode, (2) wireless headphone status, and (3) backlight status.

4. Are dimes and quarters tending to read high? This could be due to mineralization.

The status bar also displays the currently loaded program. If Autotrac is enabled, the program name may occasionally get overwritten by a “tracking” message, indicating that VX³ is adjusting its tracking point.

Pinpoint Screen

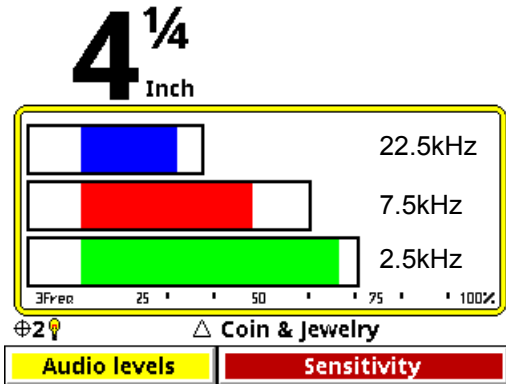

The Pinpoint screen has regions similar to the Search screen, and is accessed by pulling the trigger switch. The central part of the screen is the Pinpoint bars which show the live signal strength of the received signal, regardless of what causes it. In the screen shown, there are three of these responses, one for each frequency, again with the highest frequency on top. The top region shows depth. The same status bar and Live Control Bar are also displayed.

In 3-frequency mode the pinpoint bars show which frequency has the strongest response. In the example above, 2.5kHz is strongest. The outlining rectangle around each bar serves as a signal “peak” indicator; that is, the rectangles show the maximum peak the bars have achieved during the pinpoint activity. This is useful in determining the exact position of the target.

Salt Mode Anomaly

Normally in Pinpoint mode all targets will produce an audio response as well as the screen response. However, targets that are *below* the ground balance point will produce nulled audio response. In normal ground, this is not a problem as targets are never below the ground balance point⁵. But in saltwater hunting, the ground balance point can be close to a VDI of 0, meaning that the entire iron range could be below the balance point.

If you are saltwater-hunting and find that a target “disappears” in pinpoint mode, it is likely below the ground balance point, and it is likely iron. You will notice, however, that the Pinpoint bars still properly respond to the target, so you can still pinpoint it and dig to verify.

5. Except for *cold rocks*.

Main Menu

So far, we've mostly used the Live Control Bar and its associated menus (by pressing **VIEW**) for making changes to *VX*³. All controls and settings (except for Backlight) are available in one place called the Main Menu. It is accessed from the search screen by pressing **MENU**:



The top-level contents of the Main Menu mirror the contents of the Live Control Bar, though the order is different. The only item in the Main Menu not found in any Live Control menu is the ability to restore programs, which is covered in Chapter 7.

Navigate through the menus with the **▼** and **▲** buttons and press **ENTER** to open and close submenus. You can quickly back out of menu trees and collapse the structure as you go by pressing **MENU+◀**. Bookmarks are a convenient way to get to often-used settings and can be set (or cleared) by pressing **MENU+ENTER**. You can jump between bookmarks by pressing **MENU+▼** or **MENU+▲**.

Most selections available in the menus consist of slider controls, radio buttons, or check boxes. Sliders are changed with the ► and ◀ buttons. Note that a control has a “✓” in front of its name when the control is set to the default value. The name is preceded with a “Δ” when the value is different than the default value¹.

Tip: Use MENU+► and MENU+◀ to quickly jump a slider setting between minimum, default, and maximum values.

Bonus Tip: This also works (but with MENU+▼ and MENU+▲) in the Live Control Bar.

Finally, from any of the menus (Main Menu, or Live Control menus) you can flip the trigger switch forward and VX³ will show pop-up help balloons:

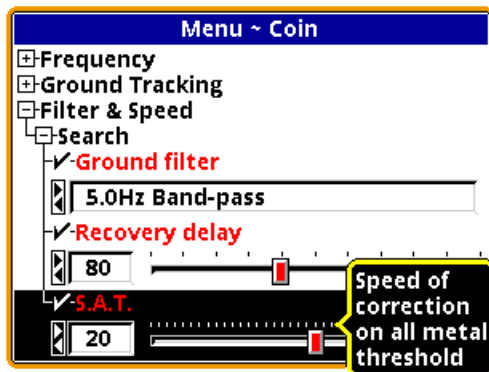

Filters & Speed

The only features of VX³ not yet discussed at all are found in the **Filter & Speed** section of the Main Menu:

1. In the Live Control pop-ups, default values are underlined.

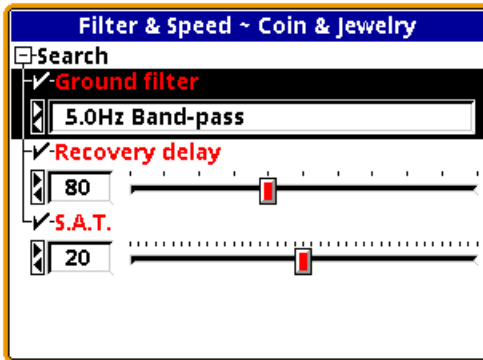

Ground Filter

Modern VLF metal detectors use electronic filters both to remove unwanted noise — such as electromagnetic interference (EMI) from radio signals and power lines — and to remove the portion of the received signal due to ground mineralization (see Chapter 1). Different filters offer trade-offs in performance. Severe mineralization usually requires more filtering which can affect depth. High EMI likewise requires more filtering. The type and amount of filtration will usually affect loop sweep speeds.

VX³ allows you to choose between two filter settings:

- 5Hz Bandpass — Lower mineralization, good EMI rejection, allows slower sweep speed
- 12.5Hz Bandpass — Higher mineralization, good EMI rejection, requires higher sweep speed

Most programs use the 5Hz Bandpass filter as the default. This is the best overall choice for low-to-moderate mineralization, has good EMI rejection, and allows for a slower sweep speed while still working well with faster sweep speeds. In extreme or highly variable mineralization VX³ can become chattery when sweeping the loop; the 12.5Hz Bandpass filter may help.

Recovery Delay

A detected target creates an audio response in the all-metal channel which exactly follows the target's received signal. In the discrimination channel, an accepted target creates an audio response which is generated near the peak of the received signal where the VDI is likely to be most accurate, especially necessary for generating a proper tone ID. A rejected target produces a null in the audio threshold. The disc tone or threshold null is maintained for a short time thereafter. This is illustrated as follows:

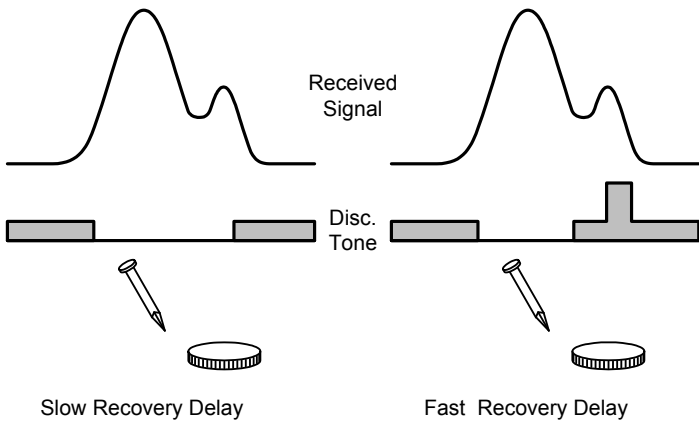

The recovery delay determines how long the disc response (tone or null) lasts. A longer delay results in a longer response. In trashy sites, a long response delay can mask targets that are close to rejected trash. Even good targets close to each other will be difficult to separate. A short response (shorter recovery delay) makes it easier to separate close targets.

The drawback to a faster response is that deep targets may not generate a long enough response to be noticeable. The default setting for recovery delay is moderately fast. In trashy sites, an alternative to reducing recovery delay is to slow down the sweep speed of the loop.

S.A.T.

SAT stands for self-adjusting threshold and is a property of the all-metal channel. In normal all-metal mode, the SAT continuously works to return the all-metal signal to a threshold point, even in the presence of ground or target signals. Therefore, when the loop is held steady over a target, the target response will eventually fade away. This helps produce a more stable all-metal audio as ground conditions vary.

A faster SAT (higher number) results in a quicker return to threshold, which can give targets a sharper all-metal response. Like a fast recovery delay, a drawback to fast SAT is that deep targets can vanish.

SAT is not applied to the Pinpoint all-metal mode. It is only noticeable in an all-metal program (like Prospecting) or a mixed-mode program.

Sensitivity Probe

If you select Sensitivity from the Live Control Bar and press **VIEW**, you will see the Sensitivity menu:

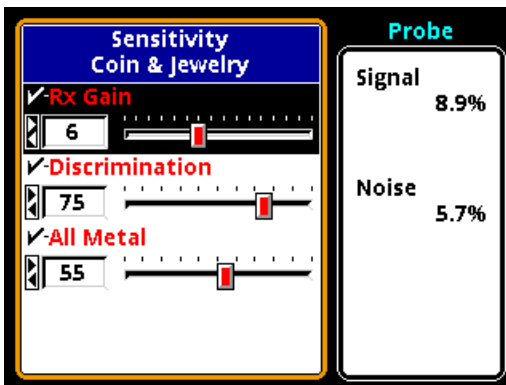

On the right side of the screen are two live “signal quality” numbers. The “Signal” number tells you what percent of the total signal range is currently being received; that is, how much

“residual” signal is being seen. Ideally, if you hold the loop in the air away from metal targets, this number should be zero. However, it is impossible to make a perfect loop null so this number is usually at least a few percent. Ground mineralization also creates a residual signal, so as you lower the loop to the ground you may see an increase in the Signal percentage.

In most cases you should adjust the Rx Gain to maintain a residual Signal of no more than 30-40%. *VX³* will overload at 60%, so it's still possible that large shallow targets will cause an overload.

Tip: An overload signal is a long, loud grunt. If you are getting a lot of overloading, drop the Rx Gain.

The Noise number represents the amount of spurious noise; that is, noise that comes and goes, as opposed to the residual signal which is continuous. This is the noise that is often audible, especially in Pinpoint mode, as chatter. A high noise level (more than a few percent) should persuade you to consider a different frequency offset, or to try the 5Hz Bandpass filter.

Ground Probe

If you select Tracking from the Live Control Bar and press **VIEW**, you will see the Tracking menu:



The right side of the screen reports the phase and strength of the residual signal², and does so for each individual frequency³. This is useful for analyzing the characteristics of the ground, but only if the residual signal consists purely of ground signal. This will be true if (1) we can get rid of other residual signals like an imperfect loop null, and (2) if we put the loop over target-free ground. To get rid of any residual loop null signal, hold the loop in the air (and away from metal, natch), **TAB** to select the **Zero** button, and press **ENTER**. Ground Probe is now zeroed, and you should see the Strength numbers go to 0% and the phase numbers jump around a lot:



Now you can lower the loop to the ground, careful to avoid targets, and the Phase and Strength numbers will be that of the ground. *VX³* is calibrated at the factory to a ferrite sample, which ideally should read 178°. Most ground mineralization should read close to that⁴.

2. Whereas the Sensitivity Probe screen only show a composite residual signal strength.
3. Of course, in single-frequency mode only that frequency is reported.
4. In Chapter 1 ground phase was described as being close to 0°. Now we say it's close to 180°! Actually, 0° is "scientifically" correct, but the *VX³* programmers like to do things backwards.

You can also use the Ground Probe to analyze target signals, and can see exactly how signal phase and strength vary with frequency. This may be of limited use in the field, however, because a buried target also has ground above it so the Ground Probe will give you the total response of the two. If the coil is placed on the ground (target-free area) when the Ground Probe is zeroed, this will largely leave you with only the target signal, but it is subject to errors due to variations in ground as you move the coil around.

As covered in Chapters 2 and 3, VX^3 comes with 8 preset factory programs. Any of these programs can be modified, and they can easily be restored to original factory settings at any time. To better understand programs, let's take a look at how VX^3 stores programs.

VX^3 Memory Structure

Below is a diagram of VX^3 's memory structure:

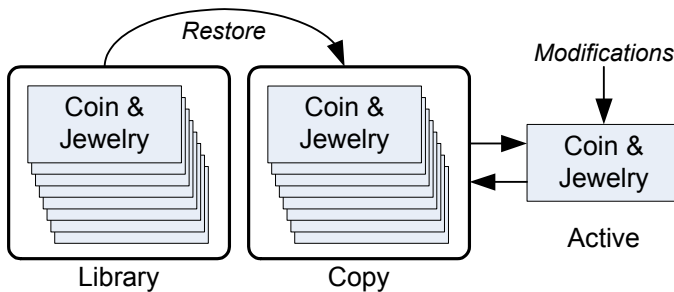

There are two memory regions, Library and Copy, plus the currently active program. The 8 factory programs are stored in the Library region which cannot be modified. Copies of the factory programs are also stored in the Copy region. This memory region can be modified.

When you start up VX^3 or change from one program to another, the active program is always loaded from the Copy region. When you change a setting, it is *only* applied to the Active program. When VX^3 is turned off, the Active program is automatically copied back to the Copy memory so that any altered settings are saved.

Tip: If you make changes and decide you don't want them automatically saved, instead of using the **ON/OFF** button to power down, simply remove the battery pack.

When modifications are made to any program so that it no longer matches the Library copy, the program name will be preceded by a “Δ” symbol. A program that has never been modified has a “✓”:

✓ **Coin & Jewelry** — original factory program

Δ **Coin & Jewelry** — modified program

Saving Programs

Program changes are automatically saved when you shut down *VX³* (via the **ON/OFF** key).

Restoring Programs

To restore a program to its original factory settings, select **MENU**→**Programs**→**Restore**:



Select the program you want to restore (it defaults to the program you are currently running), then press **TAB** to highlight the **Restore** button and press **ENTER**. The Active program is now restored.

Tip: You can also restore a program to factory defaults from the Live Control Bar. Highlight **Program Select**, highlight the program you want to restore, and press **ENTER+MENU**. A small pop-up box will appear; select the option to **Restore Defaults** and press **ENTER**.

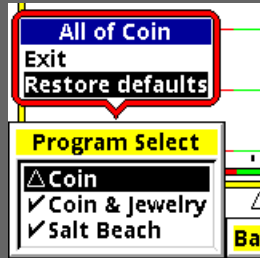

Rearranging Programs

Programs can be selected from the Live Control Bar without suspending detector operation. This can be useful if you want to quickly switch between two programs that are set up differently for the purpose of better target analysis. However, scrolling through the Live Control program list can be slow, so if you want to quickly switch between two programs you probably want them located next to each other.

It is easy to rearrange the program order in *VX³*. Select **MENU→Programs→Select** and highlight the program you want to move. Press/hold **ENTER**, then press **▲** or **▼** to move the selected program up or down through the list.

Wireless Headphones

Wireless Headphones

VX³ supports optional wireless headphones (WHPs) which are designed to use a world-wide available 2.4GHz ISM band. To enable and connect WHPs, access the WHP menu at **MENU**→**Audio**→**Wireless Headphones**. Once you enable WHPs, the menu will expand to include a number of options:

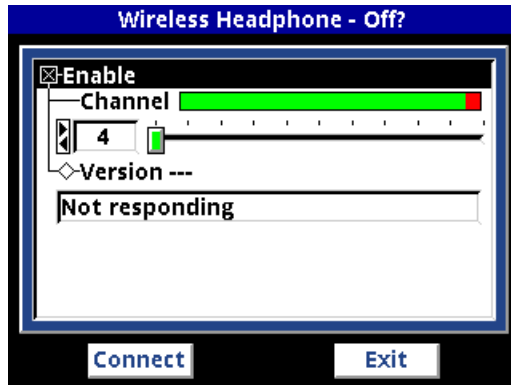

Below the menu of options are two buttons for **Connect** and **Exit**. **Connect** synchronizes the WHPs with *VX³*; if you turn on WHPs and the header bar still includes “**Off?**” or the battery report says “Not responding” then you will need to do a connect sequence.

Press the **TAB** keypad button to highlight the **Connect** button, then press **ENTER**. A pop-up balloon will prompt you to press and hold down the WHP power button:

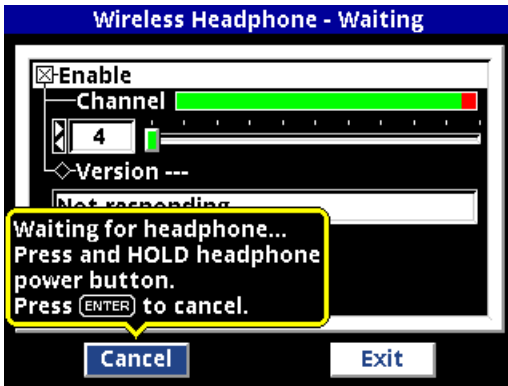

When you follow this procedure, the WHPs will produce a “ta-DA” jingle¹ which signifies proper connection. Upon connection, VX³ will pop up another balloon signifying that:



Once WHPs are properly connected, you should see the header bar report “Working.” Also, the WHP’s report back their battery voltage so you can easily check their status:

-
1. If the WHPs are not already powered on when you begin the connect sequence, you will hear a pair of “ta-DA” jingles; the first signifies power-on, the second signifies proper connection.

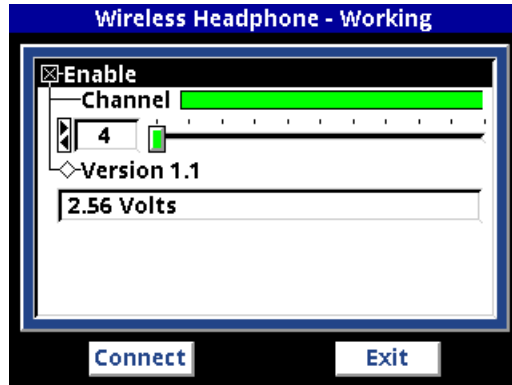

Why is there a “connect” ritual? It’s because the WHPs may need to search for and find the right channel to operate on. With the **Channel** control, *VX³* lets you select one of 76 channels (4-79), allowing multiple *V*-users to operate in close proximity. By default, channel 4 is preselected in the factory, both in *VX³* and in the WHPs. So right out of the box, you can probably turn the WHPs on and they will work fine. But if you change the channel in *VX³*, then the WHPs need to know that, hence the connect sequence. If you never change channels, you should never need to “connect,” just turn them on and go.

Tip: There are 3 ways to tell if you need to run the connect sequence once the WHPs are turned on:

One, look at the search screen; the WHP icon will have a red slash through it if the WHPs are not properly connected.

Two, look at the title bar of the WHP menu; if it says “Working,” then the WHPs are connected. If it says “Off?” then they are not connected.

Three, look at the battery voltage report in the WHP menu (below the Version number); if it says “not responding” then WHPs are not connected.

Multiple channels are provided for dealing with noise and interference from other *VX³* (or *V3/V3i*) users. If the WHP audio seems excessively noisy (cutting in and out) or you seem

to be picking up audio from another *VX³*, try a different channel. Pay attention to the reception bar when selecting a channel; choose a channel that has a maximum green and minimal red response.

Tip: If you run the connect sequence at the same time as another nearby *V*-user, you may inadvertently connect your WHPs to the wrong detector.

Finally, the WHPs send back a battery voltage status to *VX³* and the voltage is reported in the WHP menu. If the WHPs begin to act erratic, check the voltage; if its at 1.8-1.9 Volts, replace the batteries.

Murphy's Law applies every bit as well to metal detecting as anything else, so there is always something to go wrong. This chapter will cover the more common problems that people run into.

- **VX³ is excessively noisy or chattery even when the loop is held in the air.**

Most likely this is due to electromagnetic interference (EMI). Here are some strategies:

1. Adjust the frequency offset (see Ch 3) — always try this first.
2. If you are in 3-frequency mode, see if one of the single frequency modes is quieter.
3. Reduce the RxGain and/or the Disc. Sensitivity.
4. Check your surroundings... an electric fence is nearly impossible to eliminate. Other EMI sources may also be difficult to deal with.

- **VX³ is excessively noisy or chattery when the loop is swept over the ground.**

This could be due to a lot of targets (trashy site), or a poor ground balance, or due to extremely variable mineralization.

1. Use Pinpoint mode to check the area for excessive targets. If that is the case, use Locktrac instead of Autotrac, and do your best to find a sufficiently clear area to manually ground balance (Ch 2).
2. If there are not excessive targets, bob the coil up & down in Pinpoint mode at a target free spot to check the ground balance. If the audio is not reasonably constant, perform manual ground balance (Ch 2).

3. Unusually variable ground can cause problems for Autotrac; try Locktrac.
4. Slow down your sweep speed.
5. Make sure your loop is tight, and that the cable is wrapped tightly around the rod.
6. Reduce the RxGain.

- **VX³ becomes very noisy when I lay it down to dig a target.**

The Autotrac system expects to see some amount of ground signal; when you lay the detector on the ground such that the loop is tilted upwards, there is not enough ground signal available and the tracking gets “lost.” This can cause a noisy audio. When you return to hunting, simply perform a quick manual ground balance to get things back to normal.

You can also suspend detector operation while digging; a quick way to do this is to press the **MENU** key and bring up the Main Menu. Pull the trigger to resume hunting.

- **The target I dug is not what VX³ suggested it would be.**

The types of targets buried are nearly infinite, and the target icons displayed are only some of the more popular types. Many targets overlap each other; pull tabs are notoriously unpredictable as there are so many different types with different VDIs.

Sometimes a given area will have a prevalence of a particular type of pull tab (perhaps the old hermit liked a particular beer) that you will begin to recognize. Pay attention to the VDI and the SpectraGraph bars and with experience your finds will get better.

- **I'm finding a lot of clad but no silver.**

Unfortunately clad has been around now for 46 years, and tends to be shallower and easier to find. Try to get access to older home sites. Focus on deeper targets.

- **I get a target response in Disc mode but it is weak (or disappears) in Pinpoint mode.**

See Chapter 5, “Salt Mode Anomaly.” While this phenomenon is more prevalent in salt mode, it can occur in normal (non-salt) mode as well.

- **VX³ won't turn on.**

1. The batteries could be dead.
2. Ensure that the batteries are installed correctly in the tray.
3. If you know the batteries are good, then look down inside the battery compartment, there are 2 metal contact prongs. If those get bent forward, then they will not contact the battery pack contacts.

- **VX³ suddenly shuts down.**

1. The batteries could be dead.
2. *VX³* automatically shuts down if there is no keypad or trigger activity for 30 minutes.

- **VX³ is locked up, and it won't power down.**

Remove and replace the batteries.

- **The coil stem is wobbly.**

1. Ensure that the cam locks are tight.
2. Check the ends of the rod to make sure they are round and have not become oval.

- **The battery door won't stay latched.**

Make sure the battery door tabs are getting properly seated into the control box latches before snapping down the latches.

- **The arm cup is loose or wobbly.**

Use one hand to gently squeeze the sides of the arm cup inward as you tighten the retainer nut. This will make for a much tighter fit.

- **My display cover has a dent in it.**

The cover over the display is replaceable, and new covers are available from White's. Simply peel off the old one, and stick on the new one.

- **The display is very dim.**

1. In shade or indoors you may need to turn on the back-light.
2. The *VX³* display is polarized, so polarized sunglasses can severely reduce the brightness. Tilt your head from side-to-side to see if this is the problem.

- **My pinpointer is causing interference.**

This is a common problem with any detector and pinpointer. When you lay the detector on the ground, keep the loop away from the area you will be probing. You can also suspend detector operation while digging; a quick way to do this is to press the **MENU** key and bring up the Main Menu. Pull the trigger to resume hunting.

- **My accessory loop is overloading at high RXGain settings.**

White's has no control over the null quality of 3rd-party loops. In general, you will have to run the RxGain low enough to prevent overloading. Most loops that overload do so on the 22.5kHz frequency, so you can also try to run in the 2.5kHz or 7.5kHz single frequency mode.

VX3 has a number of keypad shortcuts that make certain tasks easier. They have all been mentioned throughout the manual (often in Tip boxes) and this chapter pulls them all together for quick-reference.

How to quickly ground balance

Probably the most important short-cut:

- Pull/hold the trigger, *then* press/hold **ENTER**
- Bob the loop a few times over the ground until the threshold sound is fairly constant
- Release **ENTER**, *then* release the trigger

Tip: Check the ground first (use all-metal pinpoint) to make sure there are no metal targets where you are trying to ground balance.

How to hide/expand the Live Controls

By default, the Live Controls are displayed as a horizontal menu. You can completely hide them (to increase the size of the SpectraGraph region), or expand them to include the settings (eats up more screen):

- Press **ZOOM+▲** to show/expand the Live Control Bar.
- Press **ZOOM+▼** to hide/minimize the Live Control Bar.

Tip: When you want to find the quietest frequency offset, expand the LCB, scroll over to **Transmit Frequency-Offset**, and pull the trigger to get into Pinpoint mode. Go through the offsets and look for the setting that gives the least pinpoint noise. Minimize the LCB when done.

How to organize your Program list

VX³ comes with 8 preset programs. You can change their order in the listing:

- Go to **MENU**→**Program**→**Select**
- Scroll down to highlight a desired program
- Press **ENTER+▲** (or **ENTER+▼**) to move the program through the list.

How to quickly restore a program

Suppose you make changes to a program and decide you want to return to the factory settings. From the Live Control Bar, go to **Program Select**, press **ENTER**, and highlight the desired program. Press **ENTER+MENU** and a small selection box will pop up, allowing you to Restore.

Tip: Changes made to a program are automatically saved on normal power-down. They are not saved if you unplug the battery while the detector is still running.

How to quickly check the battery voltage

Press **MENU+ENTER** from the search screen. This will bring up the “splash” screen, and the battery voltage appears at the bottom. You can also select **Backlight** on the Live Control Bar and press **VIEW**.

How to quickly turn on the Backlight

Press and hold the **ON** button for 3 seconds and the backlight will turn on to max brightness.

How to quickly collapse menus

In the VX³ main menu, if you've drilled down several levels deep and want to quickly collapse the cascaded menus, then press **MENU+◀**.

How to quickly jump through ranges

Some settings have a large range of values, such as volume. You can press **ENTER+▼** or **ENTER+▲** (or **ENTER+▶** or **ENTER+◀** if you are in the Menus) to quickly jump to the extremes of the range, and to also get back to the default setting.

Tip: A little check mark (✓) displays when the setting is at its saved default value. A delta symbol (Δ) displays when the setting has been changed.

How to fast-set discrimination masks

There are 191 VDIs, and each one can be individually accepted or rejected in discrimination mode. To quickly set a range of VDI's to the same state, select the first VDI in the range and set its state (☒ = accepted); then press **ENTER+▼** to apply the same state through the VDI list.

Tip: This works with **ENTER+▲** as well.

How to use bookmarks

If you have a few settings you like to play with in the Main Menu and want a fast way to get to them without having to navigate the menu tree, use bookmarks to tag them.

- To set a bookmark, press **MENU+ENTER**. A little bookmark symbol will appear.
- To quickly jump to successive bookmarks, press **MENU+▼** or **MENU+▲**.
- To clear a bookmark, press **MENU+ENTER**. The bookmark symbol will disappear.

Note: Bookmarks are global to all programs. You cannot set bookmarks differently in different programs.



Warranty

If within two years (24 months) from the original date of purchase, your White's detector fails due to defects in either material or workmanship, White's will repair or replace at its option, all necessary parts without charge for parts or labor.

Simply return the complete detector to the Dealer where you purchased it, or to your nearest Authorized Service Center. The unit must be accompanied by a detailed explanation of the symptoms of the failure. You must provide proof of date-of-purchase before the unit is serviced.

This is a transferable manufacturer warranty, which covers the instrument two years from the original purchase date, regardless of the owner.

Items excluded from the warranty are non-rechargeable batteries, accessories that are not standard equipment, shipping/handling costs outside the continental USA, Special Delivery costs (Air Freight, Next Day, 2nd Day, Packaging Services, etc.) and all shipping/handling costs inside the continental USA 90 days after purchase.

White's registers your purchase only if the Sales Registration Card is filled out and returned to the factory address by your dealer, soon after original purchase for the purpose of recording this information, and keeping you up-to-date regarding White's ongoing research & development.

The warranty does not cover damage caused by accident, misuse, neglect, alterations, modifications, unauthorized service, or prolonged exposure to corrosive compounds, including salt. Duration of any implied warranty (e.g., merchantability and fitness for a particular purpose) shall not be longer than the stated warranty. Neither the manufacturer or the retailer shall be liable for any incidental or consequential damages.

Some states however, do not allow the limitation on the length of implied warranties, or the exclusion of incidental or consequential damages. Therefore, the above limitations may not apply to you. In addition, the stated warranty gives you specific legal rights, and you may have other rights which vary from state-to-state.

The foregoing is the only warranty provided by White's as the manufacturer of your metal detector. Any "extended warranty" period beyond two years, which may be provided by a Dealer or other third party on your detector, may be without White's authority involvement and consent, and might not be honored by White's Electronics, Inc.



Spectra VX³

Treasure Hunter's Code of Ethics

1. Always check federal, state, county, and local laws before searching.
2. Always obtain the owner's permission before accessing private property.
3. Take care to refill all holes and leave no trace.
4. Remove and dispose of any and all trash and litter found.
5. Whenever possible, return identifiable property to its rightful owner.
6. Never destroy historical or archaeological treasures.
7. Appreciate and protect natural resources, wildlife and property, both public and private.
8. Act as an ambassador for the hobby; be thoughtful, considerate, and courteous at all times.



*White's metal detectors are proudly designed,
built, and tested in Sweet Home, Oregon USA
by the employees of White's Electronics.*